

# PPM-GIGE-2-POE

PC/104-Plus Dual Gigabit Ethernet Controller  
with Power Over Ethernet

## PRODUCT MANUAL

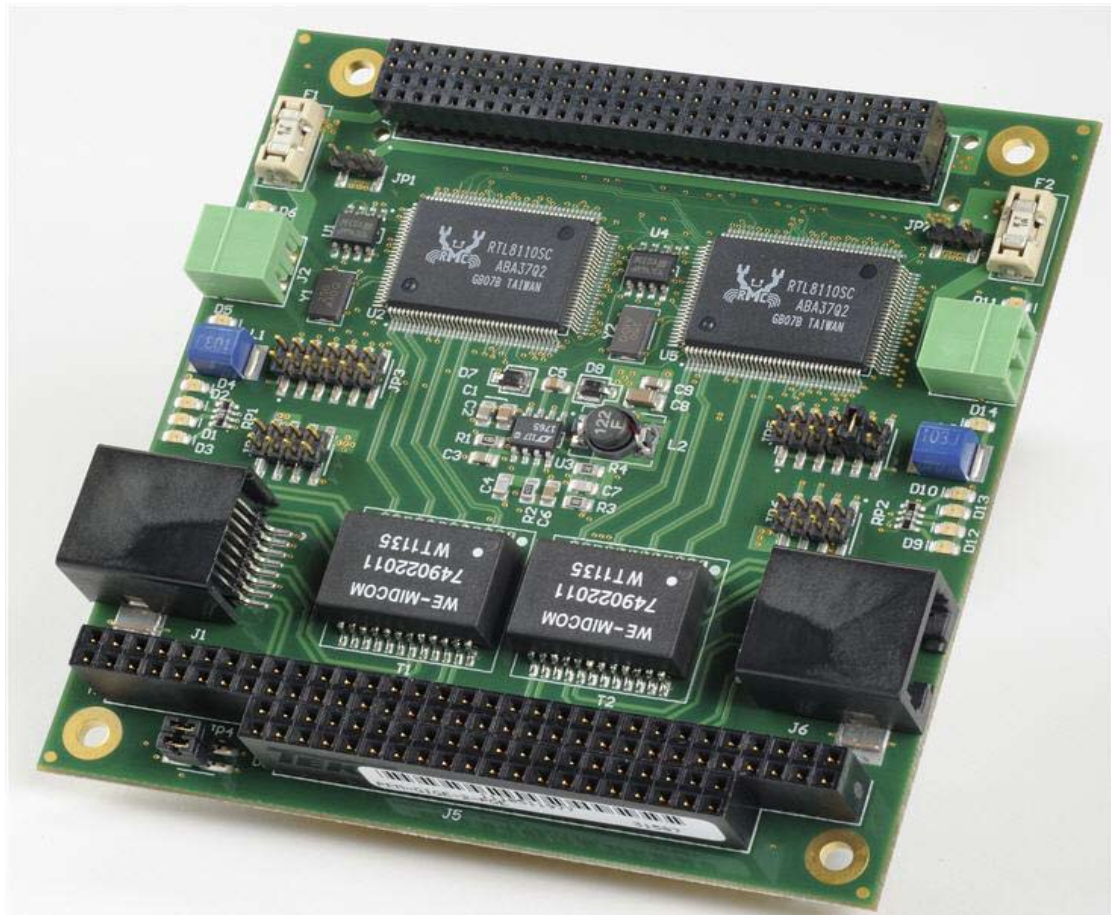

**WinSystems, Inc.**  
715 Stadium Drive  
Arlington, TX 76011

<http://www.winsystems.com>

# MANUAL REVISION HISTORY

P/N 400-0386-000

Revision Date Code	ECO Number
120402	Initial Release
120403	

# TABLE OF CONTENTS

## Contents

<b>TABLE OF CONTENTS</b> .....	<b>3</b>
<b>BEFORE YOU BEGIN</b> .....	<b>4</b>
<b>Visual Index - Top View (Connectors &amp; Jumpers)</b> .....	<b>5</b>
<b>Visual Index - Top View (LEDs)</b> .....	<b>6</b>
<b>Jumper Reference</b> .....	<b>7</b>
<b>INTRODUCTION</b> .....	<b>9</b>
<b>FEATURES</b> .....	<b>9</b>
<b>FUNCTIONALITY</b> .....	<b>10</b>
System.....	10
POE Operation.....	10
<b>CONNECTOR REFERENCE</b> .....	<b>11</b>
<b>ETHERNET</b> .....	<b>11</b>
J1, J6 - Gigabit Ethernet.....	11
Ethernet LED - D1, D3, D4, D9, D10, D13.....	11
JP4 - PCI Resource Selection.....	11
<b>POWER OVER ETHERNET</b> .....	<b>12</b>
J2 - POE Power Input (Channel 2).....	12
J7 - POE Power Input (Channel 1).....	12
JP2 - POE Power Configuration (Channel 2).....	12
JP6 - POE Power Configuration (Channel 1).....	12
JP3 - POE Mode Configuration (Channel 2).....	13
JP5 - POE Mode Configuration (Channel 1).....	14
JP1, JP7 - External POE.....	15
POE Power Supply and Output - D5, D14.....	15
POE Operation.....	15
<b>PC/104 BUS</b> .....	<b>16</b>
J3, J5 - PC/104.....	16
<b>PC/104-Plus BUS</b> .....	<b>17</b>
J4 - PC/104-Plus.....	17
<b>SPECIFICATIONS</b> .....	<b>18</b>
<b>MECHANICAL DRAWING</b> .....	<b>19</b>
<b>APPENDIX - A</b> .....	<b>20</b>
BEST PRACTICES.....	20
<b>WARRANTY INFORMATION</b> .....	<b>24</b>

## BEFORE YOU BEGIN

WinSystems offers best practice recommendations for using and handling WinSystems embedded PCs. These methods include valuable advice to provide an optimal user experience and to prevent damage to yourself and/or the product.

YOU MAY VOID YOUR WARRANTY AND/OR DAMAGE AN EMBEDDED PC BY FAILING TO COMPLY WITH THESE BEST PRACTICES.

Reference [Appendix - A](#) for **Best Practices**.



**Please review these guidelines carefully and follow them to ensure you are successfully using your embedded PC.**

For any questions you may have on WinSystems products, contact our Technical Support Group at (817) 274-7553, Monday through Friday, between 8 AM and 5 PM Central Standard Time (CST).

## Visual Index - Top View (Connectors & Jumpers)

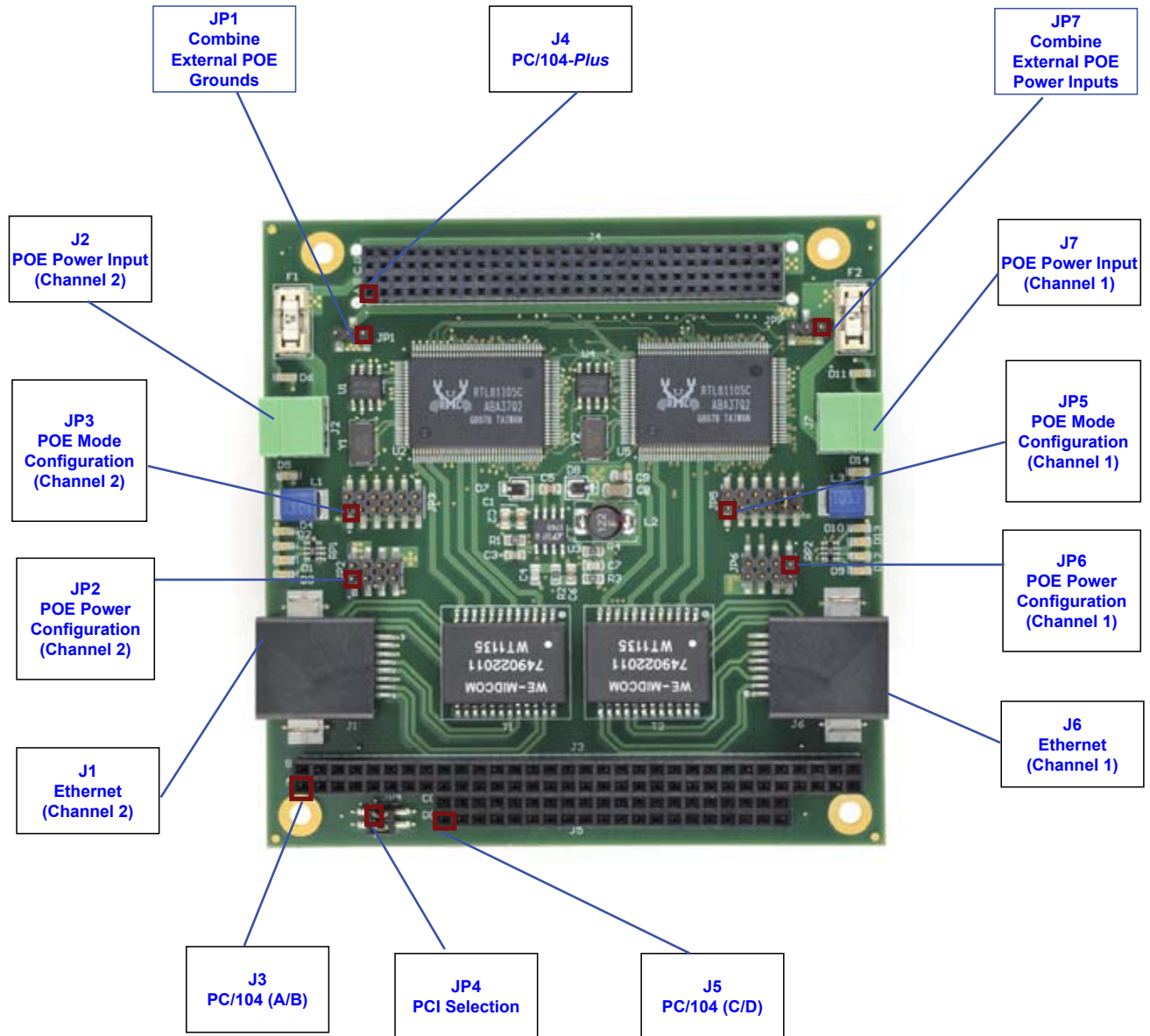

**NOTE:** The reference line to each component part has been drawn to Pin 1, and is also highlighted with a square, where applicable.

## Visual Index - Top View (LEDs)

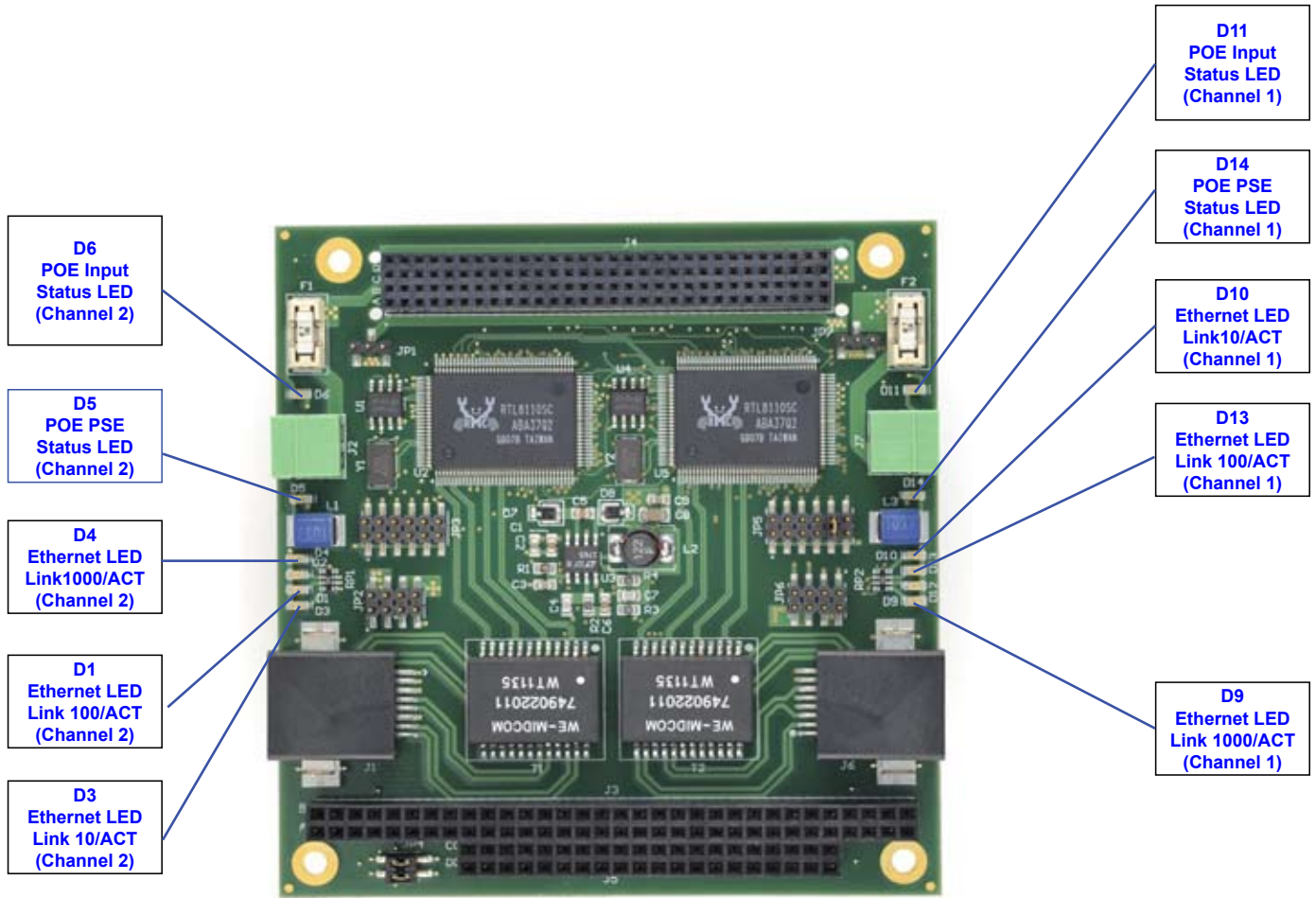

**NOTE:** The reference line to each component part has been drawn to Pin 1, and is also highlighted with a square, where applicable.

# Jumper Reference

**NOTE:** Jumper Part# SAMTEC 2SN-BK-G is applicable to all jumpers. These are available in a ten piece kit from WinSystems (Part# KIT-JMP-G-200).

## JP4 - PCI Selection

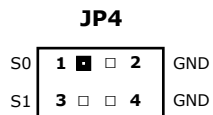

JP4 PCI Resource Selection				
	Channel 1		Channel 2	
	INT	IDSEL	INT	IDSEL
JP4 = 1-2, 3-4	A	0	B	1
JP4 = 3-4	B	1	C	2
JP4 = 1-2	C	2	D	3
JP4 = Open	D	3	-	-

## JP2 - POE Power Configuration (Channel 2)

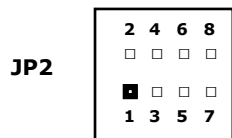

Channel 2	
Connects positive side of POE power to ENET TX Pair2 on <b>J1</b> pins 4 and 5.	1-2
Connects positive side of POE power to ENET RX Pair1 on <b>J1</b> pins 3 and 6.	3-4
Connects negative side of POE power to ENET TX Pair1 on <b>J1</b> pins 1 and 2.	5-6
Connects negative side of POE power to ENET RX Pair2 on <b>J1</b> pins 7 and 8.	7-8

## JP6 - POE Power Configuration (Channel 1)

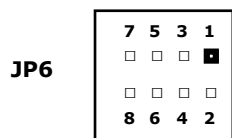

Channel 1	
Connects positive side of POE power to ENET TX Pair2 on <b>J6</b> pins 4 and 5.	1-2
Connects positive side of POE power to ENET RX Pair1 on <b>J6</b> pins 3 and 6.	3-4
Connects negative side of POE power to ENET TX Pair1 on <b>J6</b> pins 1 and 2.	5-6
Connects negative side of POE power to ENET RX Pair2 on <b>J6</b> pins 7 and 8.	7-8

## JP3 - POE Mode Configuration (Channel 2)

JP3

2	4	6	8	10	12
<input type="checkbox"/>	<input type="checkbox"/>	<input type="checkbox"/>	<input type="checkbox"/>	<input type="checkbox"/>	<input type="checkbox"/>
<input checked="" type="checkbox"/>	<input type="checkbox"/>	<input type="checkbox"/>	<input type="checkbox"/>	<input type="checkbox"/>	<input type="checkbox"/>
1	3	5	7	9	11

JP3 PD Classification		
Jumper 1-2	Jumper 3-4	Power Device Classification
Open	Open	CLASS 0-CLASS 4
Open	Installed	CLASS 5 (900 mA)
Installed	Open	CLASS 5 (850 mA)
Installed	Installed	CLASS 5 (950 mA)

JP3 POE Configuration		
	Jumper Installed	Jumper Open
5-6	LED Pulse Code Disabled	LED Pulse Code Enabled
7-8	POE Endpoint Device	POE Midspan Device
9-10	Legacy High Cap Sensing Disabled	Legacy High Cap Sensing Enabled
11-12	POE Reset (Disable)	POE Enabled

## JP5 - POE Mode Configuration (Channel 1)

JP5

2	4	6	8	10	12
<input type="checkbox"/>	<input type="checkbox"/>	<input type="checkbox"/>	<input type="checkbox"/>	<input type="checkbox"/>	<input type="checkbox"/>
<input checked="" type="checkbox"/>	<input type="checkbox"/>	<input type="checkbox"/>	<input type="checkbox"/>	<input type="checkbox"/>	<input type="checkbox"/>
1	3	5	7	9	11

JP5 PD Classification		
Jumper 1-2	Jumper 3-4	Power Device Classification
Open	Open	CLASS 0-CLASS 4
Open	Installed	CLASS 5 (900 mA)
Installed	Open	CLASS 5 (850 mA)
Installed	Installed	CLASS 5 (950 mA)

JP5 POE Configuration		
	Jumper Installed	Jumper Open
5-6	LED Pulse Code Disabled	LED Pulse Code Enabled
7-8	POE Endpoint Device	POE Midspan Device
9-10	Legacy High Cap Sensing Disabled	Legacy High Cap Sensing Enabled
11-12	POE Reset (Disable)	POE Enabled



## INTRODUCTION

This manual is intended to provide the necessary information regarding configuration and usage of the PPM-GIGE-2-POE module. WinSystems maintains a Technical Support Group to help answer questions not adequately addressed in this manual. Contact Technical Support at (817) 274-7553, Monday through Friday, between 8 AM and 5 PM Central Standard Time (CST).

## FEATURES

### Ethernet Controller

- Two Gigabit Ethernet controllers (RTL8110SC) on a *PC/104-Plus* card
- 10/100/1000 Mbps Full- / Half-Duplex operation
- Two RJ-45 connector interfaces
- Automatic switching from 1 Gbps to 100 or 10 Mbps

### Power Over Ethernet (POE)

- POE interface configurable device with up to 40W of power
- 802.3af compliant interface
- Endpoint/Midspan selectable configuration support

### MAC

#### FIFO Buffer

- 64-KByte receive and 8-KByte transmit FIFO

#### Flow Control

- IEEE 802.3.x-compliant full-duplex support

### PHY

- IEEE 802.3ab Auto-Negotiation with next page support
- 2 pair/3 pair cable downshift support

### Industrial Operating Temperature

- -40°C to 85°C

### Operating System Compatibility

- Windows XP, Windows Embedded Standard, Linux, DOS, x86 RTOS

### Power

- +5V required, 500 mA typical

### Mechanical

- Dimensions: 3.6 x 3.8 inches (90 x 96 mm)
- Weight: 3.3 oz (93g)

### Additional Specifications

- *PC/104-Plus* compliant board
- Supports 5V or 3.3V *PC/104-Plus* board
- Adaptive equalization support
- LEDs provide visual status indication

## FUNCTIONALITY

### System

The PPM-GIGE-2-POE is a high-performance, *PC/104-Plus* compliant, two channel Gigabit Ethernet module with 802.3af compliant Power Over Ethernet (POE) capabilities. This add-in *PC/104-Plus* form-factor module allows connection to two 10, 100, and 1000 Mbps networks using standard CAT5 twisted pair copper cables. The product has jumper selectable resources which configure the card's location in the *PC/104-Plus* stack. It is based upon the popular Realtek RTL8110SC controller that it is supported by a wide range of operating systems including Windows, Linux, and other x86-compatible operating systems. The POE interface is configurable as an Endpoint or Midspan device and is implemented as a Power Supplying Equipment (PSE) interface, capable of providing up to 40W of power.

### POE Operation

Each of the two Ethernet interfaces on the PPM-GIGE-2-POE supports 802.3af/at compliant POE and POE+ Power Over Ethernet. An external isolated DC power supply is required to supply the POE power for the interface. The negative side of this power supply should be connected to VEE. Both POE interfaces can use separate external DC supplies or jumpers on the board can be installed, allowing them to share a single external power source. The POE controller for each channel goes through a detection, discovery, and classification process each time a network cable is attached or removed.

The POE controller includes a multifunction LED driver to inform the user of the port status. If this feature is enabled, port status can be observed on the output LED. The LED is turned on when the port is connected to a valid PD and powered. If the port is not powered or is disconnected, the LED will be off. For two other conditions, the controller blinks a code to communicate the port status. A series of two flashes indicates an over-current fault occurred during port power-on. A series of five flashes indicates that during detection an invalid low or high discovery signature resistance was detected.

Because of the prevalence of various Telecom circuits using negative supplies which may or may not be present in a user's network, it is highly recommended that the POE controller power source also be configured as a negative supply. Using a negative supply alleviates the possibility of creating large ~100V potential differences in a system, thereby reducing the possibility of electrical shock.

# CONNECTOR REFERENCE

## ETHERNET

### J1, J6 - Gigabit Ethernet

Visual Index

PCB Connector: MOLEX 43743-8101 (J1, J6)

### RTL8110SC Gigabit Ethernet Controllers

The PPM-GIGE-2-POE is equipped with two Realtek RTL8110SC Gigabit Ethernet controllers. Each of these provide a standard IEEE 802.3 Ethernet interface for 1000/100/10BASE-T networks. The RJ-45 connections for each Ethernet port are available at **J1** (Port 2) and **J6** (Port 1). See the pin definitions below.

**J1**  
(Channel 2)

1	TXD1+
2	TXD1-
3	RXD1+
4	TXD2+
5	TXD2-
6	RXD1-
7	RXD2+
8	RXD2-

**J6**  
(Channel 1)

1	TXD1+
2	TXD1-
3	RXD1+
4	TXD2+
5	TXD2-
6	RXD1-
7	RXD2+
8	RXD2-

### Ethernet LED - D1, D3, D4, D9, D10, D13

Visual Index

On-board Ethernet activity LEDs **D9**, **D10**, and **D13** are provided for **J6** (Port 1). LEDs **D1**, **D3**, and **D4** are associated with **J1** (Port 2). See tables below for signal definitions.

**J1**  
(Ethernet Port 2)

LED	Color	Signal
D1	YELLOW	LINK100/ACT
D3	RED	LINK10/ACT
D4	GREEN	LINK1000/ACT

**J6**  
(Ethernet Port 1)

LED	Color	Signal
D13	YELLOW	LINK100/ACT
D10	RED	LINK10/ACT
D9	GREEN	LINK1000/ACT

### JP4 - PCI Resource Selection

Visual Index

The PPM-GIGE-2-POE allows for PCI resource selection for the Ethernet controllers by configuring **JP4**.

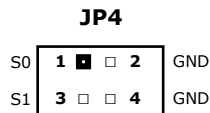

JP4 PCI Resource Selection				
	Channel 1		Channel 2	
	INT	IDSEL	INT	IDSEL
JP4 = 1-2, 3-4	A	0	B	1
JP4 = 3-4	B	1	C	2
JP4 = 1-2	C	2	D	3
JP4 = Open	D	3	-	-

## POWER OVER ETHERNET

### J2 - POE Power Input (Channel 2)

### J7 - POE Power Input (Channel 1)

PCB Connector: PHOENIX 1803277 (J2, J7)

Mating Connector: PHOENIX 1803578 (Housing)

Visual  
Index

The input voltage range should be (-32 to -60V) DC and specified to meet your POE device requirements.

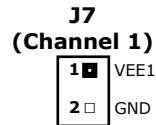
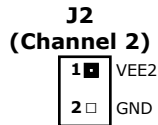

On-board POE Input Supply status indicator LEDs are provided at **D6** (Supply 2) and **D11** (Supply 1). The LEDs should be illuminated during normal operation. The LEDs will be off if VEE power is not present or if the fuse has blown.

LED	Color	Description
<b>D6</b>	YELLOW	POE Input Status 2
<b>D11</b>	YELLOW	POE Input Status 1

### JP2 - POE Power Configuration (Channel 2)

Visual  
Index

**JP2**

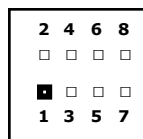

Channel 2	
Connects positive side of POE power to ENET TX Pair2 on <b>J1</b> pins 4 and 5.	1-2
Connects positive side of POE power to ENET RX Pair1 on <b>J1</b> pins 3 and 6.	3-4
Connects negative side of POE power to ENET TX Pair1 on <b>J1</b> pins 1 and 2.	5-6
Connects negative side of POE power to ENET RX Pair2 on <b>J1</b> pins 7 and 8.	7-8

### JP6 - POE Power Configuration (Channel 1)

Visual  
Index

**JP6**

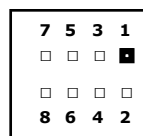

Channel 1	
Connects positive side of POE power to ENET TX Pair2 on <b>J6</b> pins 4 and 5.	1-2
Connects positive side of POE power to ENET RX Pair1 on <b>J6</b> pins 3 and 6.	3-4
Connects negative side of POE power to ENET TX Pair1 on <b>J6</b> pins 1 and 2.	5-6
Connects negative side of POE power to ENET RX Pair2 on <b>J6</b> pins 7 and 8.	7-8

**JP3** is used to configure the Channel 2 POE controller modes of operation. The Installing a jumper at **JP3** 5-6 will disable the POE controller’s internal LED pulse code feature. Leaving jumper **JP3** 5-6 uninstalled enables the POE controller’s internal LED pulse code feature. Installing a jumper at **JP3** 7-8 will configure the POE controller as a POE Endpoint device. Leaving jumper **JP3** 7-8 uninstalled configures the POE controller as a POE Midspan device. Installing a jumper at **JP3** 9-10 will disable the POE controller’s legacy high capacitance load sensing capabilities. Leaving jumper **JP3** 9-10 uninstalled enables the legacy high capacitance load sensing capability. Installing a jumper at **JP3** 11-12 will hold the POE controller in reset effectively disabling the controller. Leaving jumper **JP3** 11-12 uninstalled enables the POE controller. Jumper **JP3** 11-12 can also be used to reset the POE controller while operating. Installing and removing **JP3** 11-12 while the controller is powered causing the POE controller to reload the jumper block settings and reconfigure the POE interface mode of operation based on the new settings. **JP3** 1-2 and 3-4 are used to select which classes of POE devices are valid for operation with the controller.

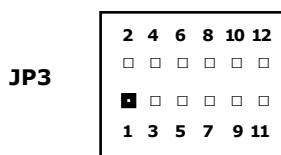

JP3 PD Classification		
Jumper 1-2	Jumper 3-4	Power Device Classification
Open	Open	CLASS 0-CLASS 4
Open	Installed	CLASS 5 (900 mA)
Installed	Open	CLASS 5 (850 mA)
Installed	Installed	CLASS 5 (950 mA)

JP3 POE Configuration		
	Jumper Installed	Jumper Open
5-6	LED Pulse Code Disabled	LED Pulse Code Enabled
7-8	POE Endpoint Device	POE Midspan Device
9-10	Legacy High Cap Sensing Disabled	Legacy High Cap Sensing Enabled
11-12	POE Reset (Disable)	POE Enabled

**JP5** is used to configure the Channel 1 POE controller modes of operation. The Installing a jumper at **JP5** 5-6 will disable the POE controller’s internal LED pulse code feature. Leaving jumper **JP5** 5-6 uninstalled enables the POE controller’s internal LED pulse code feature. Installing a jumper at **JP5** 7-8 will configure the POE controller as a POE Endpoint device. Leaving jumper **JP5** 7-8 uninstalled configures the POE controller as a POE Midspan device. Installing a jumper at **JP5** 9-10 will disable the POE controller’s legacy high capacitance load sensing capabilities. Leaving jumper **JP5** 9-10 uninstalled enables the legacy high capacitance load sensing capability. Installing a jumper at **JP5** 11-12 will hold the POE controller in reset effectively disabling the controller. Leaving jumper **JP5** 11-12 uninstalled enables the POE controller. Jumper JP5 11-12 can also be used to reset the POE controller while operating. Installing and removing **JP5** 11-12 while the controller is powered causing the POE controller to reload the jumper block settings and reconfigure the POE interface mode of operation based on the new settings. **JP5** 1-2 and 3-4 are used to select which classes of POE devices are valid for operation with the controller.

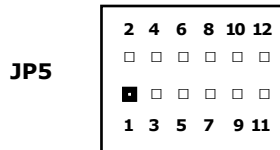

JP5 PD Classification		
Jumper 1-2	Jumper 3-4	Power Device Classification
Open	Open	CLASS 0-CLASS 4
Open	Installed	CLASS 5 (900 mA)
Installed	Open	CLASS 5 (850 mA)
Installed	Installed	CLASS 5 (950 mA)

JP5 POE Configuration		
	Jumper Installed	Jumper Open
5-6	LED Pulse Code Disabled	LED Pulse Code Enabled
7-8	POE Endpoint Device	POE Midspan Device
9-10	Legacy High Cap Sensing Disabled	Legacy High Cap Sensing Enabled
11-12	POE Reset (Disable)	POE Enabled

## JP1, JP7 - External POE

Visual Index

The PPM-GIGE-2-POE has the capability to connect two external POE power sources together so both ports can share power from a single external POE supply. This is done via the jumpers **JP1** and **JP7**.

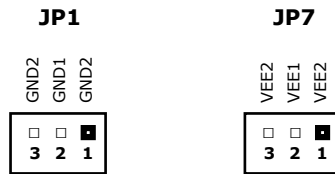

## POE Power Supply and Output - D5, D14

Visual Index

POE Power Supply Equipment (PSE) status indicator LEDs are provided at **D5** (Output 2) and **D14** (Output 1).

The input voltage range should be (-32 to -60V) DC and specified to meet your POE device requirements.

LED	Color	Description
<b>D5</b>	GREEN	POE PSE Status Output 2
<b>D14</b>	GREEN	POE PSE Status Output 1

## POE Operation

The POE controller includes a multifunction LED driver to inform the user of the port status. If this feature is enabled, port status can be observed on the output LED. The LED is turned on when the port is connected to a valid PD and powered. If the port is not powered or is disconnected, the LED will be off. For two other conditions, the controller blinks a code to communicate the port status. A series of two flashes indicates an over-current fault occurred during port power-on. A series of five flashes indicates that during detection an invalid low or high discovery signature resistance was detected.

PCB Connector:      **TEKA PC232-A-1A7-M (J3)**  
                          **TEKA PC220-A-1A7-M (J5)**

The PC/104 bus is electrically equivalent to the 16-bit ISA bus. Standard PC/104 I/O cards can be populated on PCM-SDIO's connectors, located at **J3** and **J5**. The interface does not support hot swap capability. The PC/104 bus connector pin definitions are provided below for reference. Refer to the [PC/104 Bus Specification](#) for specific signal and mechanical specifications.

<b>J5 (C/D)</b>			<b>J3 (A/B)</b>		
GND	<b>D0</b> ■ □ <b>C0</b>	GND	IOCHK#	<b>A1</b> ■ □ <b>B1</b>	GND
MEMCS16#	<b>D1</b> □ □ <b>C1</b>	SBHE#	SD7	<b>A2</b> □ □ <b>B2</b>	RESET
IOCS16#	<b>D2</b> □ □ <b>C2</b>	LA23	SD6	<b>A3</b> □ □ <b>B3</b>	+5V
IRQ10	<b>D3</b> □ □ <b>C3</b>	LA22	SD5	<b>A4</b> □ □ <b>B4</b>	IRQ
IRQ11	<b>D4</b> □ □ <b>C4</b>	LA21	SD4	<b>A5</b> □ □ <b>B5</b>	-5V
IRQ12	<b>D5</b> □ □ <b>C5</b>	LA20	SD3	<b>A6</b> □ □ <b>B6</b>	DRQ2
IRQ15	<b>D6</b> □ □ <b>C6</b>	LA19	SD2	<b>A7</b> □ □ <b>B7</b>	-12V
IRQ14	<b>D7</b> □ □ <b>C7</b>	LA18	SD1	<b>A8</b> □ □ <b>B8</b>	SRDY#
DACK0#	<b>D8</b> □ □ <b>C8</b>	LA17	SD0	<b>A9</b> □ □ <b>B9</b>	+12V
DRQ0	<b>D9</b> □ □ <b>C9</b>	MEMR#	IOCHRDY	<b>A10</b> □ □ <b>B10</b>	KEY
DACK5#	<b>D10</b> □ □ <b>C10</b>	MEMW#	AEN	<b>A11</b> □ □ <b>B11</b>	SMEMW#
DRQ5	<b>D11</b> □ □ <b>C11</b>	SD8	SA19	<b>A12</b> □ □ <b>B12</b>	SMEMR#
DACK6#	<b>D12</b> □ □ <b>C12</b>	SB9	SA18	<b>A13</b> □ □ <b>B13</b>	IOW#
DRQ6	<b>D13</b> □ □ <b>C13</b>	SD10	SA17	<b>A14</b> □ □ <b>B14</b>	IOR#
DACK7#	<b>D14</b> □ □ <b>C14</b>	SD11	SA16	<b>A15</b> □ □ <b>B15</b>	DACK3#
DRQ7	<b>D15</b> □ □ <b>C15</b>	SD12	SA15	<b>A16</b> □ □ <b>B16</b>	DRQ3
+5V	<b>D16</b> □ □ <b>C16</b>	SD13	SA14	<b>A17</b> □ □ <b>B17</b>	DACK1#
MASTER#	<b>D17</b> □ □ <b>C17</b>	SD14	SA13	<b>A18</b> □ □ <b>B18</b>	DRQ1
GND	<b>D18</b> □ □ <b>C18</b>	SD15	SA12	<b>A19</b> □ □ <b>B19</b>	REFRESH#
GND	<b>D19</b> □ □ <b>C19</b>	KEY	SA11	<b>A20</b> □ □ <b>B20</b>	BCLK
			SA10	<b>A21</b> □ □ <b>B21</b>	IRQ7
			SA9	<b>A22</b> □ □ <b>B22</b>	IRQ6
			SA8	<b>A23</b> □ □ <b>B23</b>	IRQ5
			SA7	<b>A24</b> □ □ <b>B24</b>	IRQ4
			SA6	<b>A25</b> □ □ <b>B25</b>	IRQ3
			SA5	<b>A26</b> □ □ <b>B26</b>	DACK2#
			SA4	<b>A27</b> □ □ <b>B27</b>	TC
			SA3	<b>A28</b> □ □ <b>B28</b>	BALE
			SA2	<b>A29</b> □ □ <b>B29</b>	+5V
			SA1	<b>A30</b> □ □ <b>B30</b>	OSC
			SA0	<b>A31</b> □ □ <b>B31</b>	GND
			GND	<b>A32</b> □ □ <b>B32</b>	GND

# = Active Low Signal

**NOTES:**

1. Rows C and D are not required on 8-bit modules.
2. B10 and C19 are key locations. WinSystems uses key pins as connections to GND.
3. Signal timing and function are as specified in ISA specification.
4. Signal source/sink current differ from ISA values.



PCB Connector: **TEKA 2MR430-A7WM-368-00 (J4)**

The PC/104-Plus is electrically equivalent to the 33 MHz PCI bus and is terminated to a 120-pin, nonstackthrough connector. The standard PC/104-Plus I/O modules can be populated on EPX-C380's PC104-Plus bus. The interface does not support hot swap capability. The PC/104-Plus bus connector is located at **J4**. Refer to the [PC/104-Plus Bus Specification](#) for specific signal and mechanical specifications. The pin definitions are:

PIN	A	B	C	D
1	GND	RESERVED	+5V	AD00
2	VI/O	AD02	AD01	+5V
3	AD05	GND	AD04	AD03
4	C/BE0#	AD007	GND	AD06
5	GND	AD009	AD08	GND
6	AD11	VI/O	AD10	M66EN
7	AD14	AD13	GND	AD12
8	+3.3V	C/BE1#	AD15	+3.3V
9	SERR#	GND	RESERVED	PAR
10	GND	PERR#	+3.3V	RESERVED
11	STOP#	+3.3V	LOCK#	GND
12	+3.3V	TRDY#	GND	DEVSEL#
13	FRAME#	GND	IRDY#	+3.3V
14	GND	AD16	+3.3V	C/BE2#
15	AD18	+3.3V	AD17	GND
16	AD21	AD20	GND	AD19
17	+3.3V	AD23	AD22	+3.3V
18	IDSEL0	GND	IDSEL1	IDSEL2
19	AD24	C/BE3#	VI/O	IDSEL3
20	GND	AD26	AD25	GND
21	AD29	+5V	AD28	AD27
22	+5V	AD30	GND	AD31
23	REQ0#	GND	REQ1#	VI/O
24	GND	REQ2#	+5V	GNT0#
25	GNT1#	VI/O	GNT2#	GND
26	+5V	CLK0	GND	CLK1
27	CLK2	+5V	CLK3	GND
28	GND	INTD#	+5V	RST#
29	+12V	INTA#	INTB#	INTC#
30	-12V	REQ3#	GNT3#	GND

## SPECIFICATIONS

<b>Electrical</b>	
VCC	±5V required, 500 mA typical
<b>Mechanical</b>	
Dimensions	3.6 x 3.8 inches (90 x 96 mm)
Weight	3.3 oz (93 g)
<b>Environmental</b>	
Operating Temperature	-40°C to 85°C

# MECHANICAL DRAWING

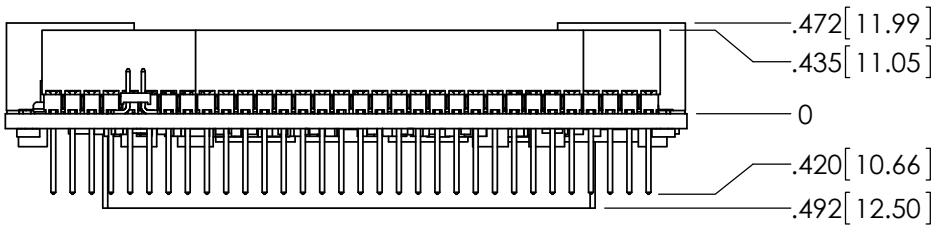
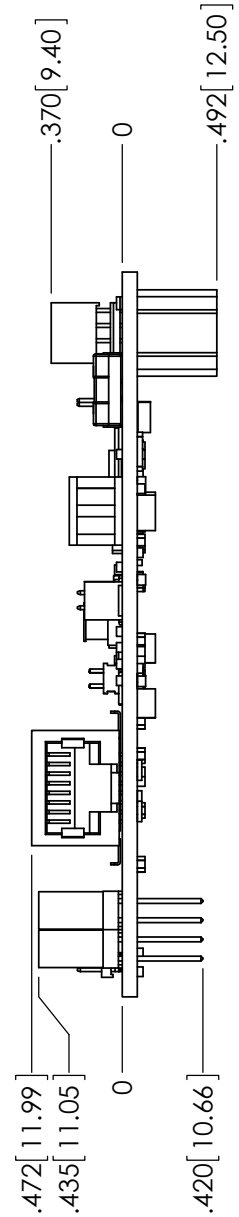
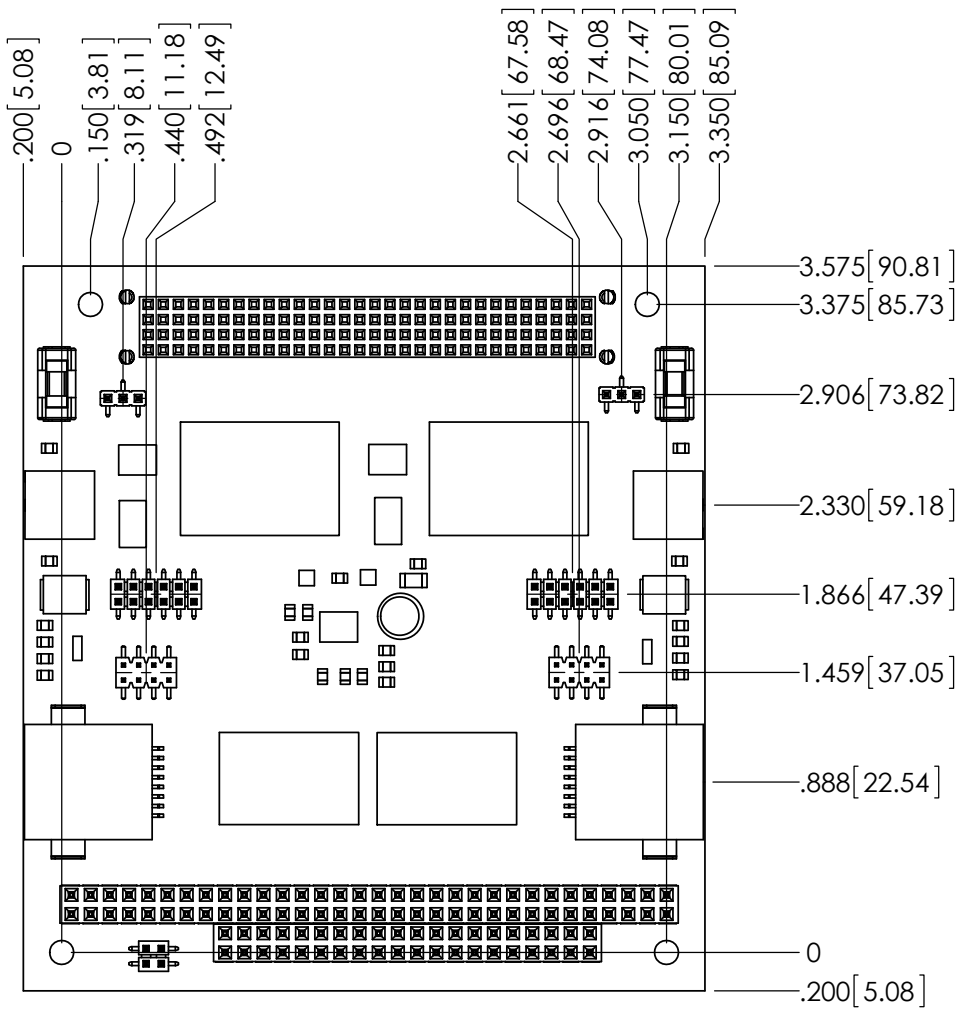

## PPM-GIGE-POE-DUAL CHANNEL

## APPENDIX - A

### BEST PRACTICES

#### POWER SUPPLY

The power supply and how it is connected to the Single Board Computer (SBC) is very important.



##### **Avoid Electrostatic Discharge (ESD)**

Only handle the SBC and other bare electronics when electrostatic discharge (ESD) protection is in place. Having a wrist strap and a fully grounded workstation is the minimum ESD protection required before the ESD seal on the product bag is broken.

##### **Power Supply Budget**

Evaluate your power supply budget. It is usually good practice to budget 2X the typical power requirement for all of your devices.

##### **Zero-Load Power Supply**

Use a zero-load power supply whenever possible. A zero-load power supply does not require a minimum power load to regulate. If a zero-load power supply is not appropriate for your application, then verify that the single board computer's typical load is not lower than the power supply's minimum load. If the single board computer does not draw enough power to meet the power supply's minimum load, then the power supply will not regulate properly and can cause damage to the SBC.



##### **Use Proper Power Connections (Voltage)**

When verifying the voltage, you should always measure it at the power connector on the SBC. Measuring at the power supply does not account for voltage drop through the wire and connectors.

The single board computer requires +5V ( $\pm 5\%$ ) to operate. Verify the power connections. Incorrect voltages can cause catastrophic damage.

Populate all of the +5V and ground connections. Most single board computers will have multiple power and ground pins, and all of them should be populated. The more copper connecting the power supply to the single board computer the better.

##### **Adjusting Voltage**

If you have a power supply that will allow you to adjust the voltage, it is a good idea to set the voltage at the power connector of the SBC to 5.1V. The SBC can tolerate up to 5.25V, so setting your power supply to provide 5.1V is safe and allows for a small amount of voltage drop that will occur over time as the power supply ages and the connector contacts oxidize.

##### **Power Harness**

Minimize the length of the power harness. This will reduce the amount of voltage drop between the power supply and the single board computer.

##### **Gauge Wire**

Use the largest gauge wire that you can. Most connector manufacturers have a maximum gauge wire they recommend for their pins. Try going one size larger; it usually works and the extra copper will help your system perform properly over time.

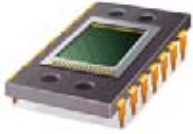

### Contact Points

WinSystems' boards mostly use connectors with gold finish contacts. Gold finish contacts are used exclusively on high speed connections. Power and lower speed peripheral connectors may use a tin finish as an alternative contact surface. It is critical that the contact material in the mating connectors is matched properly (gold to gold and tin to tin). Contact areas made with dissimilar metals can cause oxidation/corrosion resulting in unreliable connections.

### Pin Contacts

Often the pin contacts used in cabling are not given enough attention. The ideal choice for a pin contact would include a design similar to Molex's or Trifurcons' design, which provides three distinct points to maximize the contact area and improve connection integrity in high shock and vibration applications.

## POWER DOWN

Make sure the system is **completely off/powerd down** before connecting anything.



### Power Supply OFF

The power supply should always be off before it is connected to the single board computer.

### I/O Connections OFF

I/O Connections should also be off before connecting them to the single board computer or any I/O cards. Connecting hot signals can cause damage whether the single board computer is powered or not.

## MOUNTING AND PROTECTING THE SINGLE BOARD COMPUTER

### Do Not Bend or Flex the SBC

Never bend or flex the single board computer. Bending or flexing can cause irreparable damage. Single board computers are especially sensitive to flexing or bending around Ball-Grid-Array (BGA) devices. BGA devices are extremely rigid by design and flexing or bending the single board computer can cause the BGA to tear away from the printed circuit board.

### Mounting Holes

The mounting holes are plated on the top, bottom and through the barrel of the hole and are connected to the single board computer's ground plane. Traces are often routed in the inner layers right below, above or around the mounting holes.

Never use a drill or any other tool in an attempt to make the holes larger.

Never use screws with oversized heads. The head could come in contact with nearby components causing a short or physical damage.

Never use self-tapping screws; they will compromise the walls of the mounting hole.

Never use oversized screws that cut into the walls of the mounting holes.

Always use all of the mounting holes. By using all of the mounting holes you will provide the support the single board computer needs to prevent bending or flexing.

## MOUNTING AND PROTECTING THE SINGLE BOARD COMPUTER (continued)

### **Plug or Unplug Connectors Only on Fully Mounted Boards**

Never plug or unplug connectors on a board that is not fully mounted. Many of the connectors fit rather tightly and the force needed to plug or unplug them could cause the single board computer to be flexed.

### **Avoid cutting of the SBC**

Never use star washers or any fastening hardware that will cut into the single board computer.

### **Avoid Overtightening of Mounting Hardware**

Causing the area around the mounting holes to compress could damage interlayer traces around the mounting holes.

### **Use Appropriate Tools**

Always use tools that are appropriate for working with small hardware. Large tools can damage components around the mounting holes.

### **Placing the SBC on Mounting Standoffs**

Be careful when placing the single board computer on the mounting standoffs. Sliding the board around until the standoffs are visible from the top can cause component damage on the bottom of the single board computer.

### **Avoid Conductive Surfaces**

Never allow the single board computer to be placed on a conductive surface. Almost all single board computers use a battery to backup the clock-calendar and CMOS memory. A conductive surface such as a metal bench can short the battery causing premature failure.



## ADDING PC/104 BOARDS TO YOUR STACK

Be careful when adding PC/104 boards to your stack.

Never allow the power to be turned on when a PC/104 board has been improperly plugged onto the stack. It is possible to misalign the PC/104 card and leave a row of pins on the end or down the long side hanging out of the connector. If power is applied with these pins misaligned, it will cause the I/O board to be damaged beyond repair.

## OPERATIONS / PRODUCT MANUALS

Every single board computer has an Operations manual or Product manual.



### **Manual Updates**

Operations/Product manuals are updated often. Periodically check the WinSystems website (<http://www.winsystems.com>) for revisions.

### **Check Pinouts**

Always check the pinout and connector locations in the manual before plugging in a cable. Many single board computers will have identical headers for different functions and plugging a cable into the wrong header can have disastrous results.

### **Contact an Applications Engineer with questions**

If a diagram or chart in a manual does not seem to match your board, or if you have additional questions, contact your Applications Engineer.

## WARRANTY INFORMATION

<http://www.winsystems.com/company/warranty.cfm>

WinSystems warrants to Customer that for a period of two (2) years from the date of shipment any Products and Software purchased or licensed hereunder which have been developed or manufactured by WinSystems shall be free of any material defects and shall perform substantially in accordance with WinSystems' specifications therefore. With respect to any Products or Software purchased or licensed hereunder which have been developed or manufactured by others, WinSystems shall transfer and assign to Customer any warranty of such manufacturer or developer held by WinSystems, provided that the warranty, if any, may be assigned. Notwithstanding anything herein to the contrary, this warranty granted by WinSystems to the Customer shall be for the sole benefit of the Customer, and may not be assigned, transferred or conveyed to any third party. The sole obligation of WinSystems for any breach of warranty contained herein shall be, at its option, either (i) to repair or replace at its expense any materially defective Products or Software, or (ii) to take back such Products and Software and refund the Customer the purchase price and any license fees paid for the same. Customer shall pay all freight, duty, broker's fees, insurance charges for the return of any Products or Software to WinSystems under this warranty. WinSystems shall pay freight and insurance charges for any repaired or replaced Products or Software thereafter delivered to Customer within the United States. All fees and costs for shipment outside of the United States shall be paid by Customer. The foregoing warranty shall not apply to any Products of Software which have been subject to abuse, misuse, vandalism, accidents, alteration, neglect, unauthorized repair or improper installations.

THERE ARE NO WARRANTIES BY WINSYSTEMS EXCEPT AS STATED HEREIN, THERE ARE NO OTHER WARRANTIES EXPRESS OR IMPLIED INCLUDING, BUT NOT LIMITED TO, THE IMPLIED WARRANTIES OF MERCHANTABILITY AND FITNESS FOR A PARTICULAR PURPOSE, IN NO EVENT SHALL WINSYSTEMS BE LIABLE FOR CONSEQUENTIAL, INCIDENTAL OR SPECIAL DAMAGES INCLUDING, BUT NOT LIMITED TO, DAMAGES FOR LOSS OF DATA, PROFITS OR GOODWILL. WINSYSTEMS' MAXIMUM LIABILITY FOR ANY BREACH OF THIS AGREEMENT OR OTHER CLAIM RELATED TO ANY PRODUCTS, SOFTWARE, OR THE SUBJECT MATTER HEREOF, SHALL NOT EXCEED THE PURCHASE PRICE OR LICENSE FEE PAID BY CUSTOMER TO WINSYSTEMS FOR THE PRODUCTS OR SOFTWARE OR PORTION THEREOF TO WHICH SUCH BREACH OR CLAIM PERTAINS.

### WARRANTY SERVICE

1. To obtain service under this warranty, obtain a return authorization number. In the United States, contact the WinSystems' Service Center for a return authorization number. Outside the United States, contact your local sales agent for a return authorization number.
2. You must send the product postage prepaid and insured. You must enclose the products in an anti-static bag to protect from damage by static electricity. WinSystems is not responsible for damage to the product due to static electricity.