

# OPERATIONS MANUAL

## LPM/MCM-NE2000

**NOTE:** *This manual has been designed and created for use as part of the WinSystems' Technical Manuals CD and/or the WinSystems' website. If this manual or any portion of the manual is downloaded, copied or emailed, the links to additional information (i.e. software, cable drawings) will be inoperable.*

WinSystems reserves the right to make changes in the circuitry  
and specifications at any time without notice.

©Copyright 1995 by WinSystems. All Rights Reserved.

## **REVISION HISTORY**

**P/N 403-239-000**

<b>ECO Number</b>	<b>Date Code</b>	<b>Rev Level</b>
Originated	951128	A
95-124	960116	B

# TABLE OF CONTENTS

<b>Section</b>	<b>Paragraph Title</b>	<b>Page</b>
	Visual Index – Quick Reference	i
1	General Information	1-1
1.1	Features	1-1
1.2	General Description	1-1
1.3	Ethernet Overview	1-1
1.4	Specifications	1-3
2	LPM/MCM-NE2000 Technical Reference	2-1
2.1	Introduction	2-1
2.2	Bus Size Selection	2-2
2.3	Bus Clock Selection	2-2
2.4	DC/DC Converter Enable	2-2
2.5	Jumpered vs. Jumperless Mode	2-3
2.6	I/O Port Selection	2-4
2.7	Interrupt Selection	2-5
2.8	I/O vs. Shared Memory Mode	2-6
2.9	Media Type Selection	2-6
2.10	Boot ROM selection	2-7
2.11	Compatible vs. Enhanced Mode	2-8
2.12	Status LEDs	2-8
2.13	Pluscfg Configuration Utility Usage	2-9
2.14	Connector/Jumper Summary	2-14

## APPENDIX

### Warranty and Repair Information

#### **Trademarks**

AT/LANTIC™ is a registered trademark of National Semiconductor Corporation.

Ethernet™ is a registered trademark of Xerox Corporation

EtherCard PLUS™ and EtherCard PLUS 16™ are trademarks of Standard Microsystems Corporation.

IBM™, OS/2™, PC™, PC-AT™, PC-XT™ are registered trademarks of International Business Machines

MS™, MS-DOS™, MS-Windows™ are registered trademarks of Microsoft Corporation

Netware™ and Novell™ are registered trademarks of Novell Inc.

# Visual Index – Quick Reference

For the convenience of the user, a copy of the Visual Index has been provided with direct links to connector and jumper configuration data.

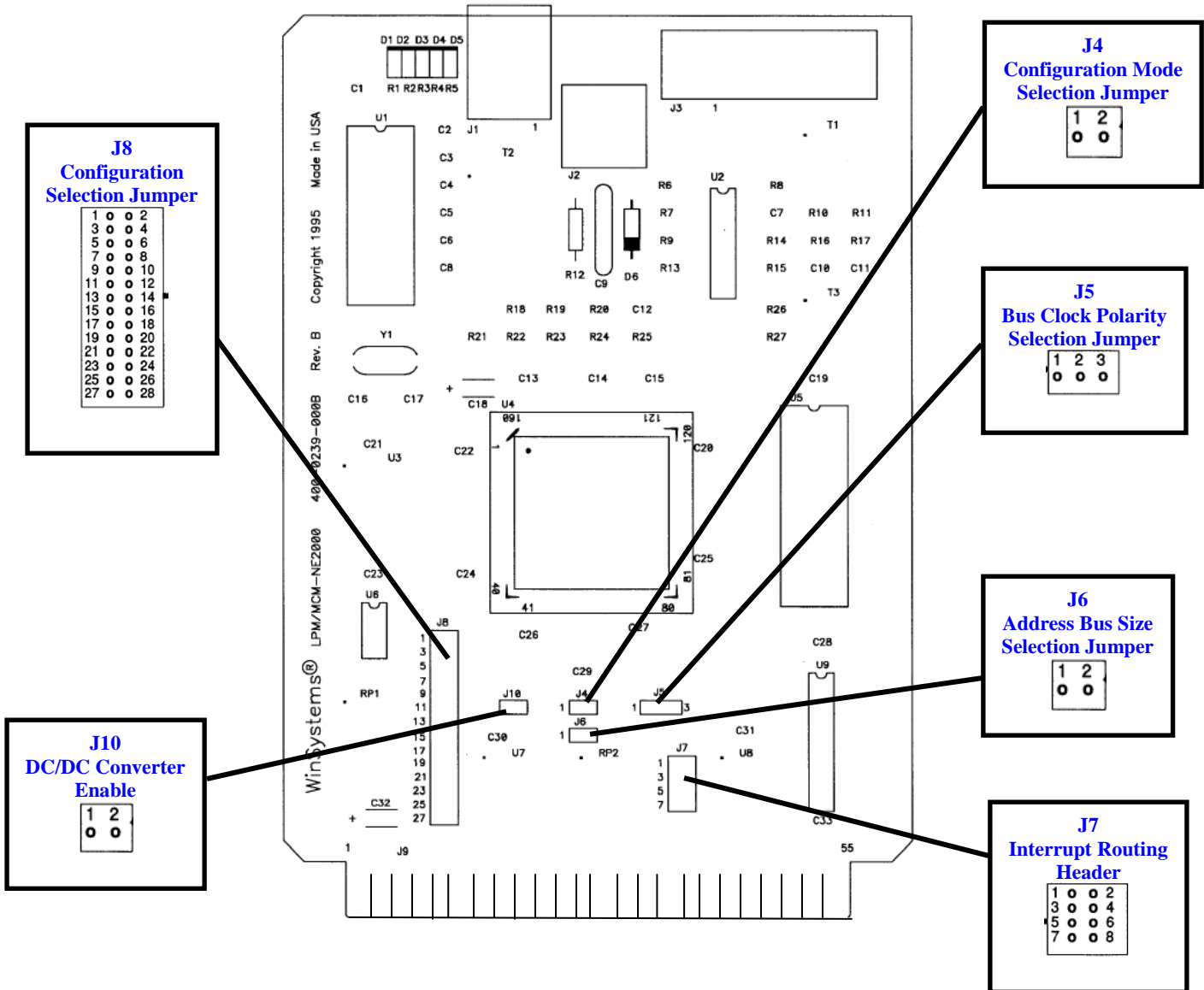

# 1

## General Information

### 1.1

#### FEATURES

- NE2000 Compatible STD-BUS Ethernet Controller
- Uses National AT/LANTIC™ High Integration Controller
- 802.3 Ethernet Compliant with 10BASE5, 10BASE2, and 10BASE-T support
- +5Volt only required in 10BASE-T and 10BASE2 Modes
- Can be configured via jumpers or jumperless through configuration software
- Onboard EEPROM stores configuration information
- Boot ROM socket for Diskless Network access

### 1.2

#### General Description

The LPM/MCM-NE2000 is an STD-BUS Ethernet adapter which is software compatible with the Novell NE2000 ISA bus Ethernet card. This compatibility allows the use of a wealth of driver software existing for the NE2000. Nearly all Network software vendors and real-time O/S vendors support the NE2000 architecture directly or with drivers they supply themselves. Support includes Netware, Lantastic, Windows for Work Groups, Windows 95, QNX, and a host of others.

The LPM/MCM-NE2000 can be configured either by using the onboard jumper block or can be used in a software-configured "jumperless" mode.

The supplied utility/driver diskette includes the configuration utility as well as ODI, NDIS, and Packet drivers.

### 1.3

#### Ethernet Overview

Ethernet is the most widely installed LAN standard for connecting personal computers and workstations with information resources, servers, and other peripherals.

The 10MBS Ethernet CSMA/CD (Carrier Sense Multiple Access with Collision Detection) protocol defines how a node will gain access to the network. The node first monitors the media to ensure that no transmissions are in progress (Carrier Sense). The node may then decide to transmit (Multiple Access). If more than one node decides to transmit simultaneously, then a collision will occur. All nodes will be able to detect this condition (Collision Detection), stop their transmissions, and retry after a random period of time.

Ethernet physical layer specifications include 10BASE5 which defines the use of thick, double-shielded coax in a bus topology. 10BASE2 defines the use of thin coax in a bus configuration. 10BASE-T defines the use of unshielded twisted pair cable in a star configuration. The table on the following page contrasts the three most common Ethernet media types.



## **1.4 SPECIFICATIONS**

### **1.4.1 Electrical**

Bus Interface: STD-8088/188 Compatible

Power Requirements: +5V +/-5% at 100mA. typ. on 10BASET and 10BASE5  
400mA typ. on 10BASE2

+12V +/-5% for AUI use only

### **1.4.2 Mechanical**

Dimensions: 4.5" X 6.5" X 0.6"

PC Board : FR4 Epoxy glass with 2 signal layers and 2 power planes with screened component legend, plated through holes, and gold-plated fingers.

Jumpers : 0.025" square posts on 0.10" centers.

Connectors : 10BASE-T - RJ45  
10BASE5 - DB15M  
10BASE2 - BNC

### **1.4.3 Environmental**

Operating Temperature : 0° to 70° C

Non-Condensing relative Humidity : 5% to 95%

## Introduction

This section of the manual is intended to provide sufficient information regarding the configuration and usage of the LPM/MCM-NE2000 STD-BUS Ethernet module. WinSystems maintains a Technical Support Group to help answer questions regarding the configuration and usage of the board. For answers to questions not adequately addressed in this manual contact Technical Support at (817) 274-7553 between 8AM and 5PM Central Time. Technical support can also be requested by mail or via FAX at (817) 548-1358.

The LPM/MCM-NE2000 is designed to offer flexible, high-performance, networking capability for the STD-BUS bus.

The LPM/MCM-NE2000 uses the National DP83905 high integration Ethernet Controller described in Section 1. A complete datasheet reprint for the AT/LANTIC™ DP83905 is reprinted in APPENDIX C for users requiring detailed information.

The LPM/MCM-NE2000 supports direct connection to 10BASE5 networks via its AUI connector at J4. Support for 10BASE2 (Thin Ethernet) is provided via a BNC connector at J2. Using third party transceivers connected to the AUI port at J3 it is also possible to support 10BASE-F (Fiber-optic Ethernet). Support for twisted-pair 10BASE-T is provided directly through the RJ45 connector at J5.

An onboard EEPROM holds the Ethernet Address and optional configuration information. This allows for "jumperless" configuration using software to configure the board for its operating mode, media type, I/O address, interrupt, etc. A software utility "Pluscfg" is provided to configure the module. Refer to Section 2.13 for use of the configuration program. The LPM/MCM-NE2000 also supports a "jumpered" configuration usable for non-DOS applications where the configuration utility is not usable.

Probably the LPM/MCM-NE2000's most attractive feature is the software compatibility with the industry standard NE2000 architecture. This compatibility virtually assures the availability of supporting software and drivers for everything from Netware to Windows 95. Although a number of drivers are provided with the LPM/MCM-NE2000, on the driver/utility diskette, the board is fully compatible with any software or drivers written for the NE2000 architecture.



## 2.2 Bus Size Selection

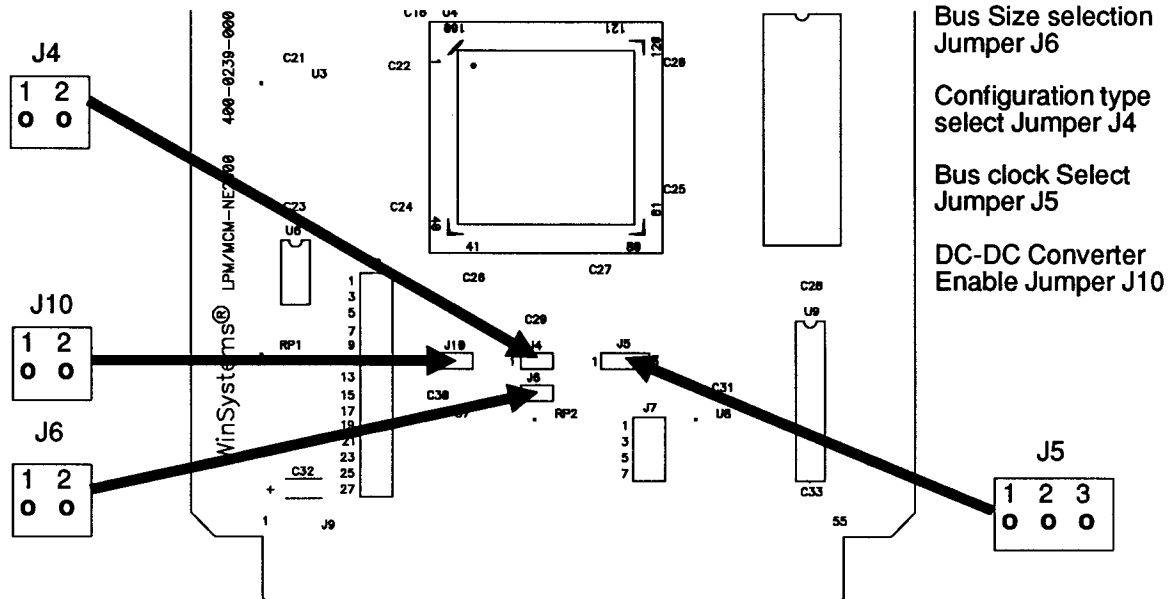

The LPM/MCM-NE2000 can be used with 80X86 CPUs generating either a 20-bit, (V40) or 24-bit (80286 and above) address when accessing memory. The jumper block at J6 allows for this selection and should be configured as shown below for the proper address bus size.

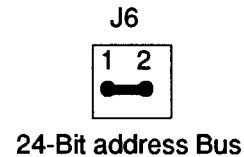
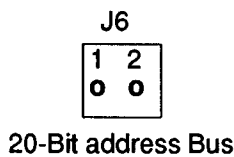

## 2.3 Bus Clock Selection

A jumper block at J5 allows for polarity selection for the STD-BUS clock line. This jumper is provided to allow compatibility with a number of STD-BUS CPU cards. The Normal setting for J5 is jumpered pins 2-3 to select an inverted bus clock. A non-inverted bus clock may also be selected by jumpering J5 pins 1-2.

## 2.4 DC-DC Converter Enable

The LPM/MCM-NE2000 supports three media types, twisted pair (10BASET), thin coax (10BASE2), and thick coax (10BASE5). J10 when jumpered enables the DC-DC converter necessary for thin coax (BNC Connector) use. This jumper MUST be removed for thick coax (AUI) use. For 10BASET (twisted pair) the jumper position does not matter although an unnecessary 300mA current is drawn on the 5 volt line.

## 25 Jumpered vs. Jumperless Mode

The LPM/MCM-NE2000 can be configured either through the jumper block at J8 (detailed in later sections) or via the configuration information stored in the onboard EEPROM. The source for the configuration information is selected via the jumper at J4 as shown below:



**NOTE:** The choice of "jumpered" or "jumperless" is totally exclusive. This means that if "jumperless" mode is selected all of the jumpers on J8 are ignored and the configuration information comes totally from the EEPROM. Similarly, if "jumpered" mode is selected the information in the EEPROM (Except for the Ethernet Address) is ignored.

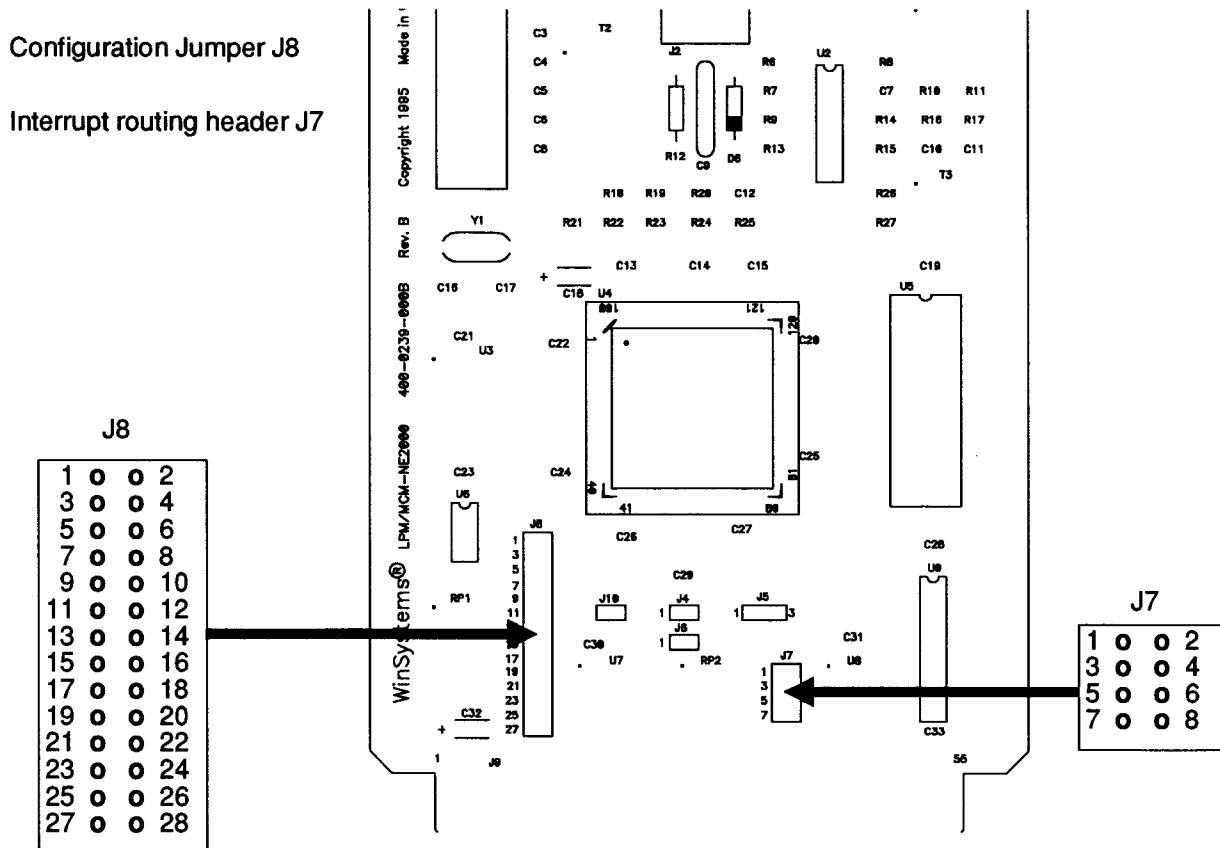

The following sections detail the J8 jumpering when the "jumpered" mode is selected.

## 2.6 I/O Port Selection

The LPM/MCM-NE2000 uses 32 consecutive I/O address in the 80X86 I/O space. The base address is selected using three pins on the J8 configuration jumper. The choices available are :

- 240H
- 280H
- 2C0H
- 300H
- 320H
- 340H
- 360H

The proper jumpering for each of these choices is shown in the following illustrations.

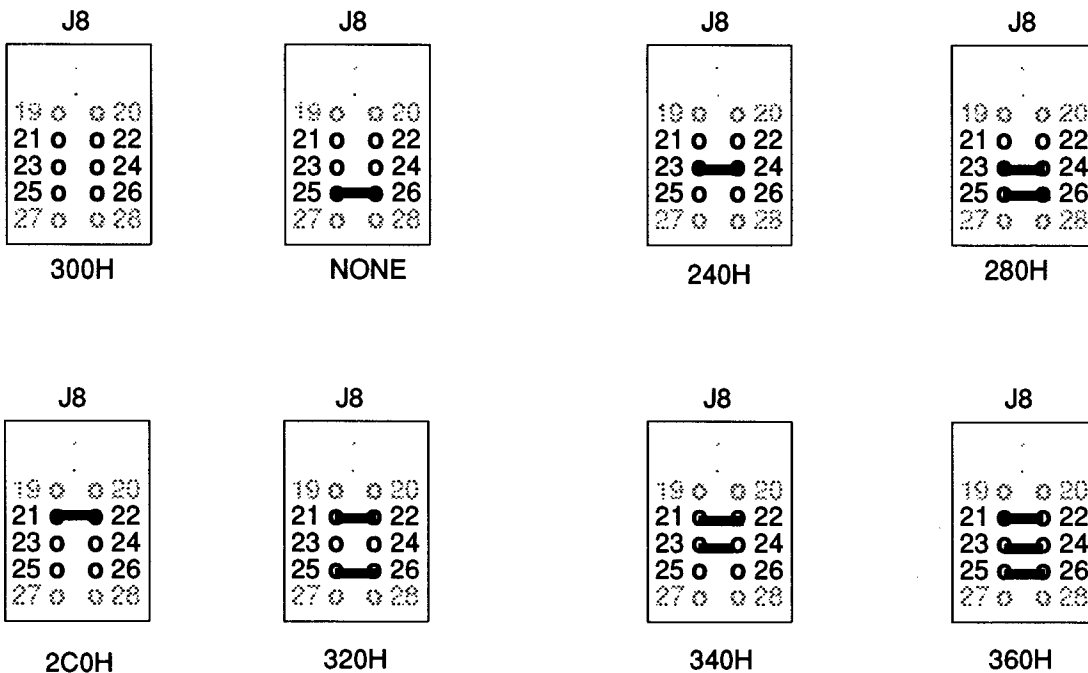

## 2.7 Interrupt Selection

The LPM/MCM-NE2000 needs an interrupt line for signaling various conditions to the software driver. There are 8 possible choices as shown here :

- IRQ 3
- IRQ 4
- IRQ 5
- IRQ 9
- IRQ 10
- IRQ 11
- IRQ 12
- IRQ 15

The proper jumpering for the three relevant jumper positions corresponding to the available interrupt choices are shown here :

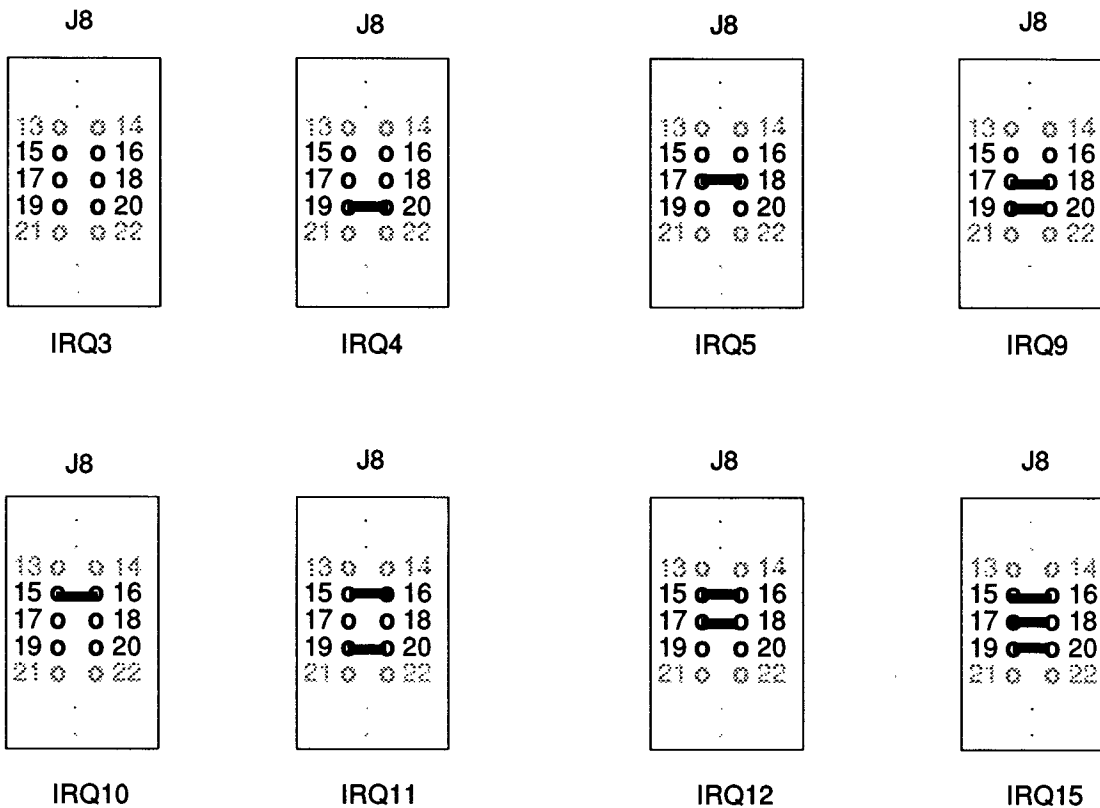

Once the interrupt has been selected it is then necessary to route the interrupt over an unused STD-BUS pin and also to configure the CPU board to accept the interrupt over the chosen line and route it to the proper input on the CPU's interrupt controller. Refer to your CPU board documentation for details on interrupt routing. The illustration on the following page shows the J7 interrupt routing header.

J7

1	o	o	2	STD-BUS PIN 44
3	o	o	4	STD-BUS PIN 37
5	o	o	6	STD-BUS PIN 50
7	o	o	8	STD-BUS PIN 46

**NOTE :** It is necessary to jumper J7 and to route the interrupt on the CPU board even in the "jumperless" mode as the STD-BUS has no preassigned interrupts on the back-plane.

## 2.8 I/O vs Shared Memory Mode

The buffer RAM within the LPM/MCM-NE2000 can be accessed in either of 2 ways. In the typical NE2000 compatible mode, the RAM is accessed through the NIC via I/O ports. An alternate access scheme is available using the shared memory mode. In this mode the board is software compatible with the WD8013EBT from Standard Microsystems (formerly Western Digital). In this mode a 32K window in the PC adapter space is used to access packet memory. The address of this window is controlled by the driver. For NE2000 compatibility the I/O mode is selected. The jumpering for each of the access modes is shown below :

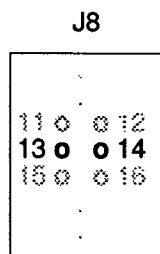

I/O MODE

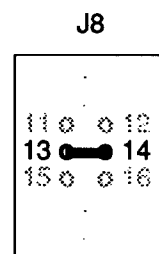

SHARED MEMORY MODE

## 2.9 Media Type Selection

The media type is also jumper selectable via 2 pins on J8. The available choices are:

- Twisted-Pair 10BASE-T
- Thin Ethernet Coax
- AUI
- Twisted-Pair 10BASE-T Reduced Squelch<sup>1</sup>

**NOTE :** Refer to section 2.4 for proper jumpering of J10 which controls the onboard DC-DC converter module.

The J8 jumpering for each of the options is shown below.

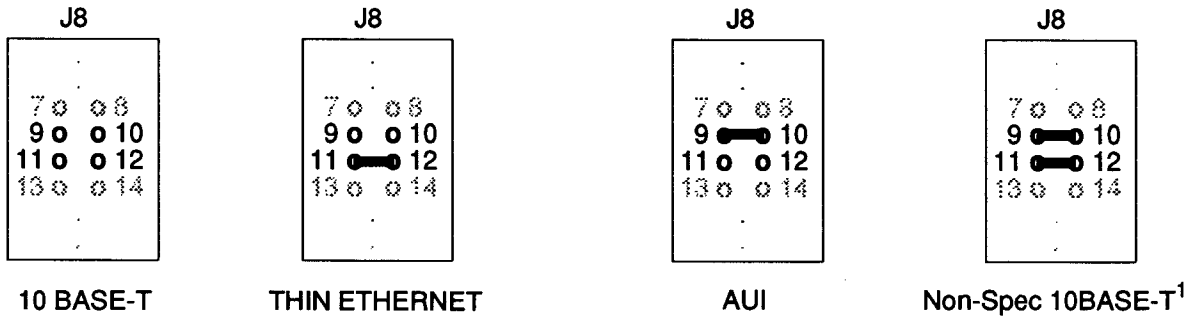

<sup>1</sup>The non-spec Twisted-pair mode with reduced squelch levels allows the use of longer cable lengths than specified in the twisted-pair specification, or the use of cable with higher losses.

## 2.10 Boot ROM Selection

The LPM/MCM-NE2000 supports the use of the remote boot feature available with Novell and some other operating systems by providing a BIOS Extension boot ROM socket. A user supplied ROM may be installed into U5. The ROM should be a 32K X 8 device of 150nS or faster (type 27C256). The address of the ROM can be selected via a set of jumpers on J8. The addresses available are :

C0000H  
C8000H  
D0000H  
D8000H

The correct jumpering for each of the supported addresses is shown here :

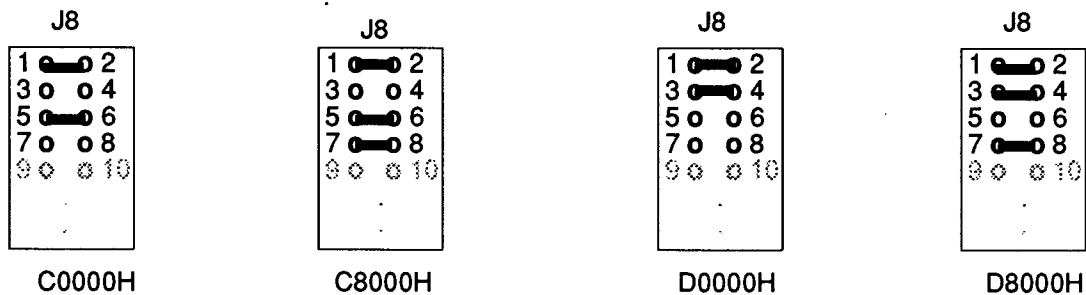

**Note :** Jumper combinations other than those shown will not result in proper recognition of the ROM. With no jumpers installed the ROM is disabled.

## 2.11 Compatible Vs. Enhanced Mode

The LPM/MCM-NE2000 uses a 32K byte buffer RAM on board. In compatible mode only 8K is accessible to the driver. When the non-compatible mode is chosen the full 32K is available from the RAM. This Enhanced mode is generally supported by the supplied AT/LANTIC™ drivers but may not be usable with generic NE2000 software or drivers. When in doubt, choose the compatible mode.

The J8 jumpering for the compatible and enhanced modes are shown here :



## 2.12 Status LEDs

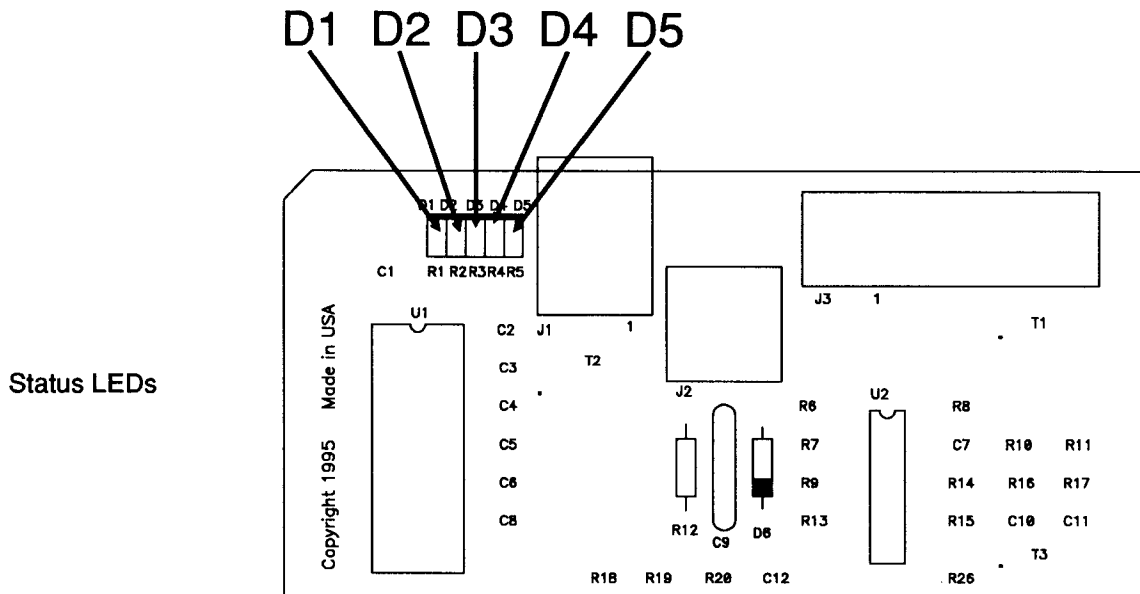

There are five LEDs installed on the LPM/MCM-NE2000. These status LEDs give visual indication as to the status of the board. The color, location, and general description of each of the status LEDs follows :

- D1 GREEN - Transmit activity
- D2 GREEN - Receive activity (All packets on network)
- D3 RED - Collision
- D4 YELLOW - Link Integrity, or testing disabled
- D5 YELLOW - Twisted-pair polarity reversed

## 2.13 Pluscfg Configuration Utility

When the "jumperless mode is selected (See Section 2.5), the configuration is made via software which is then saved to the onboard EEPROM. PLUSCFG.EXE along with MESSAGE.MSG can be run from the provided floppy or can be copied to a hard disk. From the DOS command line PLUSCFG.EXE is executed by typing :

```
pluscfg [Enter]
```

The configuration program will load and display the basic menu and configuration screen. If any AT/LANTIC™, or NE2000 adapters are recognized they will be displayed in a window on the right side of the screen as shown below:

WinSystems Thick/Thin/TPI August 20, 1993 11:34PM	PLUSCFG V1.17	AT/LANTIC Configuration Software								
<p style="text-align: center;"><b>CONFIGURATION</b></p> <p>Configure New Adapter                  Display/Change Adapter Configuration</p> <p>Diagnostics</p> <p>Quit and Return to DOS</p>	<p style="text-align: center;"><b>AT/LANTIC ADAPTERS</b></p> <table style="width: 100%; border-collapse: collapse;"> <thead> <tr> <th style="text-align: left;">I/O Port</th> <th style="text-align: left;">Mode</th> <th style="text-align: left;">IRQ</th> </tr> </thead> <tbody> <tr> <td>0x320</td> <td>I/O Port</td> <td>10</td> </tr> <tr> <td>0x360</td> <td>I/O Port</td> <td>5</td> </tr> </tbody> </table>	I/O Port	Mode	IRQ	0x320	I/O Port	10	0x360	I/O Port	5
I/O Port	Mode	IRQ								
0x320	I/O Port	10								
0x360	I/O Port	5								
***** Make Selection using arrow keys and <enter> ***** ***** Scroll through options using <tab> *****										

From the main menu choose the desired function. Each of the main menu choices will be discussed in the following sections.

### 2.13.1 Configure New Adapter

This screen is used to configure an installed adapter that is not present in the window on the right side of the screen. Typically this would be a board that had it's I/O port set to "None".

Two choices are provided to configure the new adapter.



WinSystems Thick/Thin/TPI August 20, 1993 11:34PM	PLUSCFG V1.17	AT/LANTIC Configuration Software											
<div style="border: 1px solid black; padding: 5px; text-align: center; margin-bottom: 10px;">                     CONFIGURATION                 </div> <div style="border: 1px solid black; padding: 5px; margin-bottom: 10px;">                     CONFIGURE NEW ADAPTER                 </div> <p style="margin-left: 20px;">                     Configure New Adapter Automatically                      Configure New Adapter Manually                        Return to previous menu                 </p>	<table style="width: 100%; border-collapse: collapse;"> <thead> <tr> <th colspan="3" style="text-align: center; padding: 5px;">AT/LANTIC ADAPTERS</th> </tr> <tr> <th style="text-align: left; padding: 5px;">I/O Port</th> <th style="text-align: left; padding: 5px;">Mode</th> <th style="text-align: left; padding: 5px;">IRQ</th> </tr> </thead> <tbody> <tr> <td style="padding: 5px;">0x320</td> <td style="padding: 5px;">I/O Port</td> <td style="padding: 5px;">10</td> </tr> <tr> <td style="padding: 5px;">_____</td> <td></td> <td></td> </tr> </tbody> </table>	AT/LANTIC ADAPTERS			I/O Port	Mode	IRQ	0x320	I/O Port	10	_____		
AT/LANTIC ADAPTERS													
I/O Port	Mode	IRQ											
0x320	I/O Port	10											
_____													
***** Make Selection using arrow keys and <enter> ***** ***** Scroll through options using <tab> *****													

The "Configure New Adapter Automatically" option will search out an unconfigured adapter if present, survey the system, and make automatic choices for I/O address and interrupts for what it believes are free for use. The system will then display a series of configuration options to the user. These options include :

- Adapter Architecture - I/O Port or Shared Memory
- Select Cable Interface - Thin Ethernet or Thick Ethernet or 10BASE-T

The second prompt will only be presented if there is no active cable attached or the program is unable to determine the media type.

The "Configure New Adapter Manually" option presents a screen similar to the one shown on the following page.

Use the up and down arrow keys and the tab key to change the displayed configuration to what is desired and then select "Save Configuration" to program the EEPROM with the selected choices.

**Note:** PLUSCFG will not allow selection of I/O ports, interrupts, or memory addresses that it believes are being used by other hardware in the system. If PLUSCFG refuses to allow a desired selection for what you know are valid choices, it will be necessary to use the "jumpered" mode described earlier, for configuration.

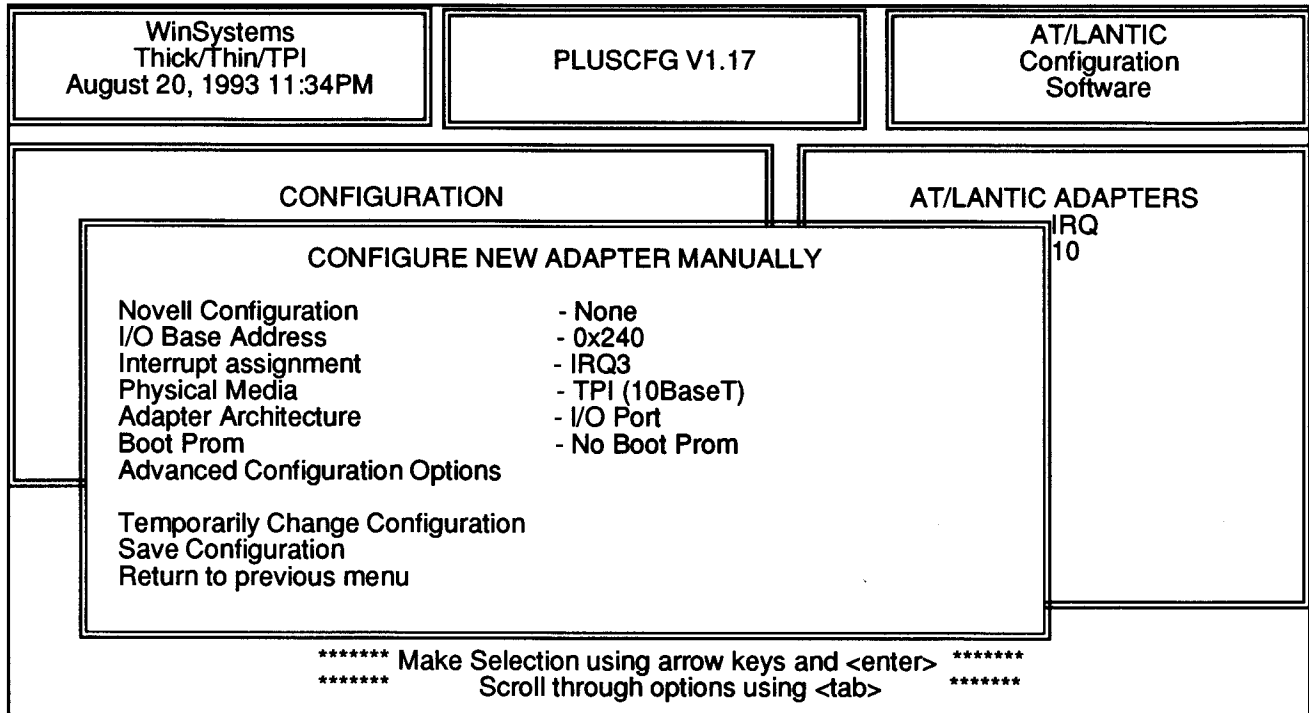

### 2.13.2 Display/Change Adapter Configuration

This option of the main menu presents the same screen as shown for the "Configure New Adapter Manually". Use the up and down arrow keys and the tab key to alter the configuration as desired and then select "Save Configuration" to program the EEPROM with the new information.

**Note:** PLUSCFG will not allow selection of I/O ports, interrupts, or memory addresses that it believes are being used by other hardware in the system. If PLUSCFG refuses to allow a desired selection for what you know are valid choices, it will be necessary to use the "jumpered" mode described earlier, for configuration.

**IMPORTANT NOTE :** The interrupt routing is **NOT** automatic (jumperless). J7 must be properly jumpered to route the interrupt to the STD-BUS. It is also necessary to configure the CPU board to accept this routing. Refer to Section 2.7 for details on interrupt routing.

### 2.13.3 Diagnostics

This third choice from the main menu allows the selection from the diagnostics sub-menu as shown in this screen shown on the following page:

WinSystems Thick/Thin/TPI August 20, 1993 11:34PM	PLUSCFG V1.17	AT/LANTIC Configuration Software											
<div style="border: 1px solid black; padding: 5px; margin: 5px;"> <p style="text-align: center;">CONFIGURATION</p> <div style="border: 1px solid black; padding: 5px; margin: 5px;"> <p style="text-align: center;">INITIALIZATION AND DIAGNOSTICS</p> <p>Adapter Initialization &amp; disagnostics Advanced Network Diagnostics</p> <p>Return to previous menu</p> </div> </div>	<table border="1" style="width: 100%; border-collapse: collapse;"> <tr> <th colspan="3" style="text-align: center;">AT/LANTIC ADAPTERS</th> </tr> <tr> <th style="text-align: left;">I/O Port</th> <th style="text-align: left;">Mode</th> <th style="text-align: left;">IRQ</th> </tr> <tr> <td>0x320</td> <td>I/O Port</td> <td>10</td> </tr> <tr> <td>0x360</td> <td>I/O Port</td> <td>5</td> </tr> </table>	AT/LANTIC ADAPTERS			I/O Port	Mode	IRQ	0x320	I/O Port	10	0x360	I/O Port	5
AT/LANTIC ADAPTERS													
I/O Port	Mode	IRQ											
0x320	I/O Port	10											
0x360	I/O Port	5											
<p>***** Make Selection using arrow keys and &lt;enter&gt; *****</p> <p>***** Scroll through options using &lt;tab&gt; *****</p>													

#### 2.13.4 Adapter Initialization & Diagnostics

This choice initializes the selected adapter and confirms I/O address, interrupt, media type, etc. The adapter should be connected to the network cable at this time. A sample screen is shown below :

WinSystems Thick/Thin/TPI August 20, 1993 11:34PM	PLUSCFG V1.17	AT/LANTIC Configuration Software					
<div style="border: 1px solid black; padding: 5px; margin: 5px;"> <p style="text-align: center;">CONFIGURATION</p> <div style="border: 1px solid black; padding: 5px; margin: 5px;"> <p style="text-align: center;">INITIALIZATION AND DIAGNOSTICS</p> <div style="border: 1px solid black; padding: 5px; margin: 5px;"> <p style="text-align: center;">INITIALIZATION AND DIAGNOSTICS</p> <p>Network Interface Controller (080017086050).....OK</p> <p>Buffer Memory Check.....OK</p> <p>Check cable connection (Cable Connected).....OK</p> <p>Interrupt Assignment (5).....OK</p> <p>Boot Prom Check (No Boot Prom).....OK</p> <p>Press &lt;ESC&gt; to return to previous menu.</p> </div> </div> </div>	<table border="1" style="width: 100%; border-collapse: collapse;"> <tr> <th colspan="3" style="text-align: center;">AT/LANTIC ADAPTERS</th> </tr> <tr> <th style="text-align: left;">I/O Port</th> <th style="text-align: left;">Mode</th> <th style="text-align: left;">IRQ</th> </tr> </table>	AT/LANTIC ADAPTERS			I/O Port	Mode	IRQ
AT/LANTIC ADAPTERS							
I/O Port	Mode	IRQ					
<p>***** Make Selection using arrow keys and &lt;enter&gt; *****</p> <p>***** Scroll through options using &lt;tab&gt; *****</p>							

**NOTE :** The Initialization & Diagnostics option must be run and pass before any of the Advanced diagnostics can be executed.

**2.13.5** Advanced Network Diagnostics

The Advanced Network Diagnostics menu is shown below.

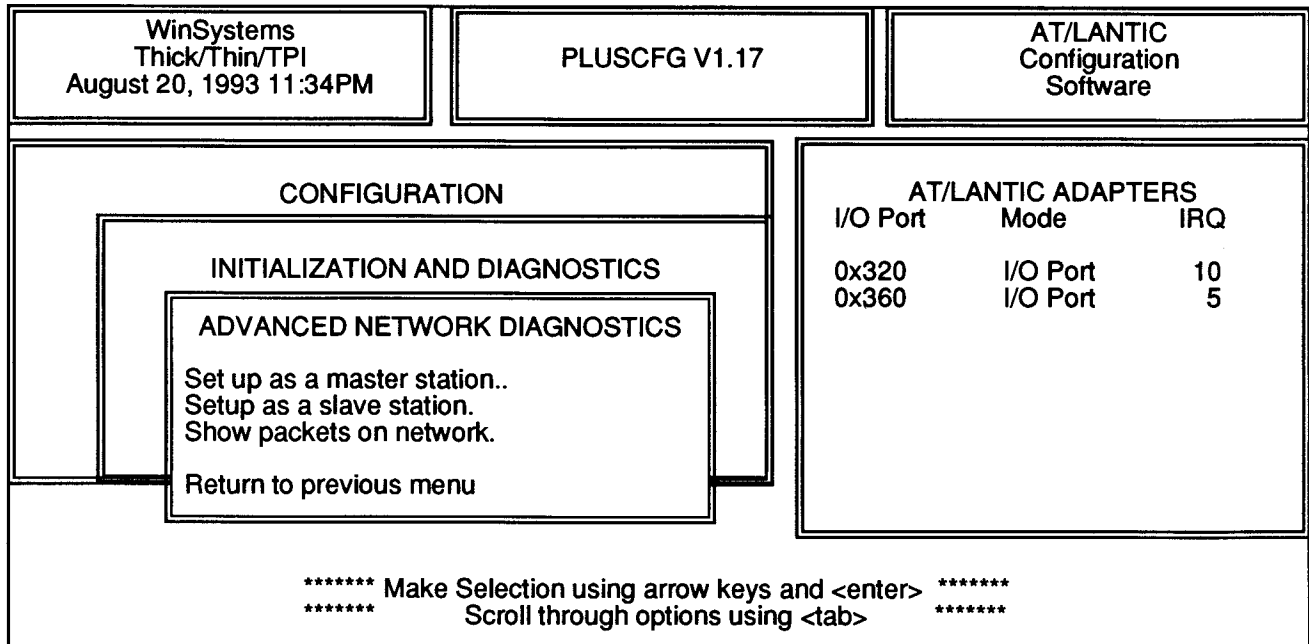

Three choices are provided for Advanced Network Diagnostics.

**2.13.6** Setup as a Master Station.

This enables the board under test to be set up as the Master. The master will initiate testing. The Slave must be enabled prior to starting the Master.

The system will then request a packet repetition length and after entered will begin the test.

**2.13.7** Set up as Slave Station.

This choice should be made for a known good board. It will echo back across the network all packets initiated by the Master.

**2.13.8** Show Packets On Network

This option displays in HEX and ASCII packets as they are received from the network. A sample screen is shown on the following page:

WinSystems Thick/Thin/TPI August 20, 1993 11:34PM	PLUSCFG V1.17	AT/LANTIC Configuration Software
---	---------------	--

**RECEIVED PACKET CONTENTS**

Received Status : 01 Next Pointer : 54 Receiver Length : 1493  
 Destination 0040F698A3E6 Source : 0040F6988448  
 Length/Type : 05C3 Hex HW CRC : D703A649 SW CRC : NORMAL

```

0450 98 7D D0 40 03 00 00 00 01 00 00 00 00 01 04   ..).@.....
0460 51 33 33 87 02 01 00 00 04 00 20 44 6F 63 2D   Q33.....(Doc-
0470 06 00 F0 76 41 47 44 53 54 4D 00 00 00 40 E1 7A   ..vAGDSTM...@.z
0480 74 BF 05 00 02 77 4D 44 54 47 53 00 04 00 0C 77   t...wMDTGS...w
0490 41 43 50 52 0E 00 14 77 41 43 44 49 4E 4F 50 52   ACPR...wACDINO
04A0 53 54 55 58 4F 47 0E 00 26 77 41 43 44 49 4E 4F   STUXMG..&aACDINO
04B0 50 52 53 54 55 58 4D 47 0C 00 38 77 49 54 45 4D   PRSTUXMG..8wITEM
04C0 20 4B 45 59 0C 00 54 77 56 41 4C 49 44 20 54 52   KEY ...Hw###,
04D0 23 23 23 59 0C 00 54 77 56 41 4C 49 44 20 54 53   ###Y...TwALID.TR
04E0 41 4E 53 3A 07 00 64 77 23 23 23 2C 23 23 23 52   ANS:...dw###,###R
            
```

Press <ESC> when finished examining receive packet

### 2.13.9 Quit and return to DOS

This main menu option exits Pluscfg and returns you to the DOS prompt.

### 2.14 Connector Jumper Summary

Connector/ Jumper	Description	Page Reference
J1	RJ-45 10BASET Connector	N/A
J2	10BASE2 BNC Connector	N/A
J3	AUI Connector	N/A
J4	Configuration Mode select jumper	2-3
J5	Bus Clock polarity select jumper	2-2
J6	Address bus size select jumper	2-2
J7	Interrupt routing header	2-6
J8	Configuration Select Jumper	2-3
J9	STD-BUS Connector	N/A
J10	DC-DC Converter Enable	2-2

# APPENDIX

## DP80366 AT/LANTIC Controller Datasheet Reprint

Sample Netware files for NE2000 compatible products	<a href="#">DP83905_ATLANTIC_.pdf</a>
---	---------------------------------------

### Cables

Part Number	Description
<a href="#">CBL-147-1</a>	16-pin ribbon to 15-pin D-Sub AUI adapter cable

### Software Examples

Sample Netware files for NE2000 compatible products	<a href="#">ATLANTIC.ZIP</a>
Utility disk image for NE2000 compatible products	<a href="#">NE2000.ZIP</a>

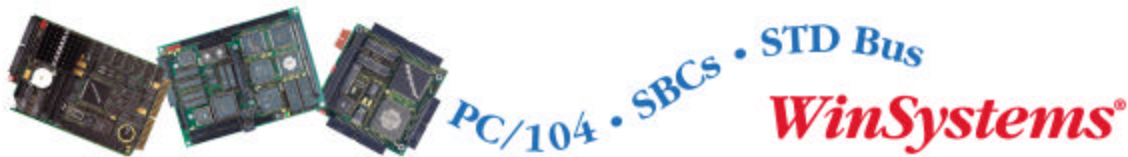

Telephone: 817-274-7553 • Fax: 817-548-1358  
<http://www.winsystems.com> • E-mail: [info@winsystems.com](mailto:info@winsystems.com)

## WARRANTY

WinSystems warrants that for a period of two (2) years from the date of shipment any Products and Software purchased or licensed hereunder which have been developed or manufactured by WinSystems shall be free of any material defects and shall perform substantially in accordance with WinSystems' specifications therefore. With respect to any Products or Software purchased or licensed hereunder which have been developed or manufactured by others, WinSystems shall transfer and assign to Customer any warranty of such manufacturer or developer held by WinSystems, provided that the warranty, if any, may be assigned. The sole obligation of WinSystems for any breach of warranty contained herein shall be, at its option, either (i) to repair or replace at its expense any materially defective Products or Software, or (ii) to take back such Products and Software and refund the Customer the purchase price and any license fees paid for the same. Customer shall pay all freight, duty, broker's fees, insurance charges and other fees and charges for the return of any Products or Software to WinSystems under this warranty. WinSystems shall pay freight and insurance charges for any repaired or replaced Products or Software thereafter delivered to Customer within the United States. All fees and costs for shipment outside of the United States shall be paid by Customer. The foregoing warranty shall not apply to any Products or Software which have been subject to abuse, misuse, vandalism, accidents, alteration, neglect, unauthorized repair or improper installations.

**THERE ARE NO WARRANTIES BY WINSYSTEMS EXCEPT AS STATED HEREIN. THERE ARE NO OTHER WARRANTIES EXPRESS OR IMPLIED INCLUDING, BUT NOT LIMITED TO, THE IMPLIED WARRANTIES OF MERCHANTABILITY AND FITNESS FOR A PARTICULAR PURPOSE, IN NO EVENT SHALL WINSYSTEMS BE LIABLE FOR CONSEQUENTIAL, INCIDENTAL, OR SPECIAL DAMAGES INCLUDING, BUT NOT LIMITED TO, DAMAGES FOR LOSS OF DATA, PROFITS OR GOODWILL. WINSYSTEMS' MAXIMUM LIABILITY FOR ANY BREACH OF THIS AGREEMENT OR OTHER CLAIM RELATED TO ANY PRODUCTS, SOFTWARE, OR THE SUBJECT MATTER HEREOF, SHALL NOT EXCEED THE PURCHASE PRICE OR LICENSE FEE PAID BY CUSTOMER TO WINSYSTEMS FOR THE PRODUCTS OR SOFTWARE OR PORTION THEREOF TO WHICH SUCH BREACH OR CLAIM PERTAINS.**

## WARRANTY SERVICE

All products returned to WinSystems must be assigned a Return Material Authorization (RMA) number. To obtain this number, please call or FAX WinSystems' factory in Arlington, Texas and provide the following information:

1. Description and quantity of the product(s) to be returned including its serial number.
2. Reason for the return.
3. Invoice number and date of purchase (if available), and original purchase order number.
4. Name, address, telephone and FAX number of the person making the request.
5. Do not debit WinSystems for the repair. WinSystems does not authorize debits.

After the RMA number is issued, please return the products promptly. Make sure the RMA number is visible on the outside of the shipping package.

The customer must send the product freight prepaid and insured. The product must be enclosed in an anti-static bag to protect it from damage caused by static electricity. Each bag must be completely sealed. Packing material must separate each unit returned and placed as a cushion between the unit(s) and the sides and top of the shipping container. WinSystems is not responsible for any damage to the product due to inadequate packaging or static electricity.