

ITX-P-C444

Industrial Single Board Computer with
NXP i.MX 8M Processor, 4K UltraHD
Video and Low Power Processing

Product Manual

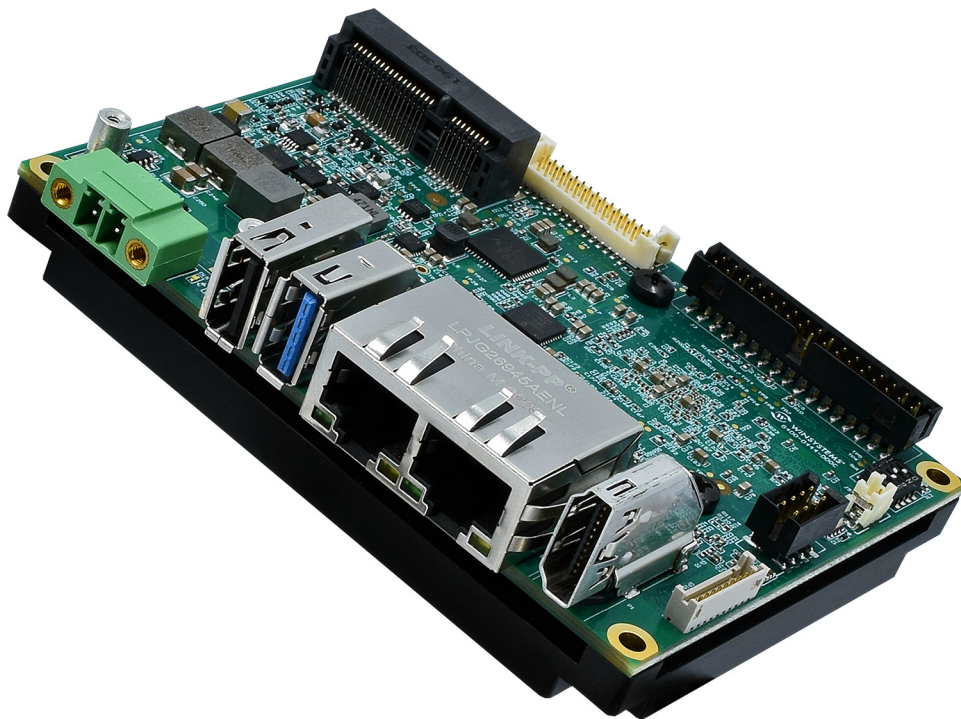

Revision History

Document Version	Last Updated Date	Brief Description of Change
V1.0	6/24/2020	Initial release
v1.1	8/25/2020	Added power usage numbers to specifications
v1.2	2/1/2021	Added cable part number
V1.3	2/22/2022	Updated COM ports 1 and 2 pin reference
V1.4	12/16/2022	Updated RS422/RS485 pin reference table
V1.5	0/11/23	New cover image, minor updates

Copyright and Trademarks

Copyright 2023, WINSYSTEMS, Inc.

No part of this document may be copied or reproduced in any form or by any means without the prior written consent of WINSYSTEMS, Inc. The information in the document is subject to change without notice. The information furnished by WINSYSTEMS, Inc. in this publication is believed to be accurate and reliable. However, WINSYSTEMS, Inc. makes no warranty, express, statutory, implied or by description, regarding the information set forth herein or regarding the freedom of the described devices from patent infringement. WINSYSTEMS, Inc. makes no warranty of merchantability or fitness for any purpose. WINSYSTEMS, Inc. assumes no responsibility for any errors that may appear in this document.

Trademark Acknowledgments

WINSYSTEMS is a registered trademark of WINSYSTEMS, Inc.

Mili-grid is a trademark of Molex, Inc.

The terms HDMI, HDMI High-Definition Multimedia Interface, and the HDMI Logo are trademarks or registered trademarks of HDMI Licensing Administrator, Inc.

NXP and the NXP logo are trademarks of NXP B.V.

Arm and Cortex are registered trademarks of Arm Limited (or its subsidiaries) in the US and/or elsewhere.

All other marks are the property of their respective companies.

Table of Contents

1	Before You Begin	5
1.1	Warnings	5
2	Introduction	5
3	Functionality	5
4	Features	6
5	General Operation	8
5.1	System Block Diagram	8
6	Specifications	9
7	Configuration	10
7.1	Component Layout	10
7.1.1	Top View	10
7.2	Watchdog Timer (WDT)	11
7.2.1	WDT Register Usage.....	11
7.3	Real-time Clock/Calendar	11
7.4	Connectors	12
7.4.1	J12 - Power Input Connector	12
7.4.2	J5 - External Battery Header	12
7.4.3	J10 - USB 2.0 Type-A Connector	13
7.4.4	J4 - Mini PCIe Connector	13
7.4.5	J13 - microSD Connector.....	13
7.4.6	J7 - USB 3.1 Gen 1 Type-A Connector	13
7.4.7	J9 - HDMI	13
7.4.8	J8 - HD Audio Header.....	13
7.4.9	J1 - MIPI-CSI Header	14
7.4.10	J2 - LVDS and Backlight Header	15
7.4.11	J6 - USB 2.0 Header	16
7.4.12	J11 - Ethernet (LAN) Dual RJ45	16
7.4.13	J3 - Multi I/O (GPIO, I2C, SPI, 2x Serial, RST, and PWR Buttons).....	17
7.5	Jumpers	18
7.5.1	SW1 - Board Configuration Jumpers	18

7.6	LED Indicators	19
8	UBOOT Setup	19
8.1	Accessing UBOOT on the ITX-P-C444	19
8.2	UBOOT, SDK, and BSP Support	19
9	Accessories and Cables	20
10	Software Drivers	20
A	Best Practices	21
B	Mechanical Drawings	25
C	Warranty Information	26

1. Before You Begin

Review the warnings in this section and the best practice recommendations (see “Best Practices” on page 21) when using and handling the WINSYSTEMS ITX-P-C444 board. Following these recommendations provides an optimal user experience and prevents damage. Read through this document and become familiar with the ITX-P-C444 before proceeding.



FAILING TO COMPLY WITH THESE BEST PRACTICES MAY DAMAGE THE ITX-P-C444 AND VOID YOUR WARRANTY.

1.1 Warnings

Only qualified personnel should configure and install the ITX-P-C444. While observing best practices, pay particular attention to the following.



Avoid electrostatic discharge (ESD)

Only handle the circuit board and other bare electronics when electrostatic discharge (ESD) protection is in place. Having a wrist strap and a fully grounded workstation is the minimum ESD protection required before the ESD seal on the product bag is broken.

2. Introduction

This manual provides configuration and usage information for the ITX-P-C444. If you still have questions, contact Technical Support at (817) 274-7553, Monday through Friday, between 8 AM and 5 PM Central Standard Time (CST).

Refer to the WINSYSTEMS website at <http://www.winsystems.com/> for other accessories (including cable drawings and pinouts) that can be used with your ITX-P-C444.

3. Functionality

The ITX-P-C444 is an industrial Pico-ITX single board computer (SBC) based upon NXP's i.MX 8M application processor and packed with dual Ethernet, industrial I/O, and expansion options.

The processor supports industry-leading video processing along with an Arm Cortex-M4 microcontroller for real-time subsystems making it an ideal fit for industrial IoT applications requiring performance in harsh conditions such as digital signage, industrial automation, energy, building automation, and others.

Solid state storage options include an mSATA socket and soldered down eMMC device for operating systems (OS) and applications.

Expansion options are provided through the Mini PCIe socket.

The ITX-P-C444 board supports up to 4 GB of soldered down LPDDR4 RAM.

4. Features

The ITX-P-C444 provides the following features.

Single board computer

- Arm® Cortex®-A53 based NXP i.MX 8M processor with Cortex-M4 core
 - i.MX 8M industrial dual core, up to 1.3 GHz
 - i.MX 8M industrial quad core, up to 1.3 GHz

Operating systems (compatibility)

- Linux
- Qt Embedded BSP

Memory

- Up to 4 GB LPDDR4 industrial soldered down RAM

Video interfaces (supports two simultaneous displays)

- 1x HDMI 2.0a
 - 4096 x 2160 at 60 Hz
 - HDR10
- Single-channel, low-voltage differential signaling (LVDS)
 - 18 and 24 bpp color panel support

Capture

- 1x MIPI-CSI capture interface

Audio

- 1x HD Audio interface (Line Out, Line In, Mic In)

Ethernet

- 1x Intel 10/100/1000 Mbps controller
- 1x i.MX 8M MAC 10/100/1000 Mbps via Microchip PHY

Storage

- microSD socket

- eMMC solid state disk

Data acquisition

- 6x GPIO bidirectional lines
- 1x SPI bus
- 1x I2C bus

Bus expansion

- M.2 Socket 1, with E key, type 2230
- Mini PCIe card (mPCIe, USB)
- microSD socket

Serial interface

- 2x RS232/422/485 serial ports

USB

- 1x USB 3.1 Gen 1 port
- 3x USB 2.0 (1x front panel I/O)

Power

- Supports a wide range DC input power: 9V to 36V
- External battery connector (external battery is optional)

Industrial operating temperature

- -40 to +85°C (-40 to +185°F)

Additional features

- Hardware security - Trusted Platform Module (TPM) 2.0 enabled
- Watchdog timer adjustable from 1 second to 255 minute reset
- RoHS compliant
- Backlight power supported
- TXCO RTC clock/calendar

5. General Operation

5.1 System Block Diagram

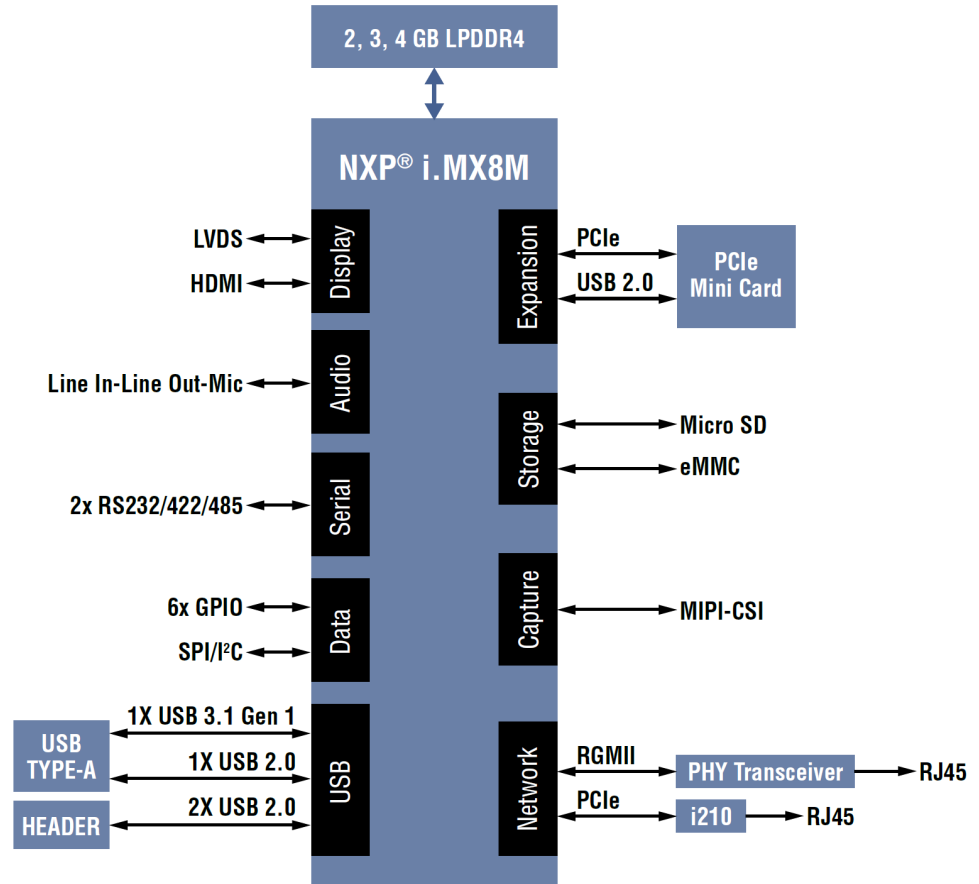

The WINSYSTEMS ITX-P-C444 SBC features a dual or quad-core processor and up to 4 GB of soldered down LPDDR4 RAM.

The ITX-P-C444 supports Linux and Qt Embedded. Drivers are available from the WINSYSTEMS website.

6. Specifications

The ITX-P-C444 adheres to the following specifications and requirements.

Feature	Specification
Electrical	
V _{CC}	Supports a wide range DC input power: 9V to 36V
Average power usage	ITX-P-C444D-2-16 = 7.34 W ITX-P-C444Q-2-16 = 7.65 W
Models	ITX-P-C444P-R-M P = CPU (D = dual core, Q = quad core) R = RAM (2, 4) M = EMMC (0*, 16, 32)
Processor	i.MX 8M dual core, up to 1.3 GHz i.MX 8M quad core, up to 1.3 GHz
Mechanical	
Dimensions	3.93 in x 2.83 in (100 mm x 72 mm)
Weight	5.95 oz. (168.5 g)
PCB thickness	0.078 in. (1.98 mm)
Environmental	
Temperature	-40 to +85°C (-40 to +185°F)
Humidity (RH)	5% to 95% non-condensing
Mechanical shock testing	IEC 60068-2-27, half sinusoidal, accel. 40g, pulse duration 6 ms, 3 positive and 3 negative shocks per all axis.
Random vibration testing	IEC 60068-2-64, Freq. 10 Hz to 2000 Hz, 1 Hr each axis.
RoHS compliant	Yes
Operating Systems	
Runs Linux, Qt Embedded.	

* Special order only.

7. Configuration

This section describes the ITX-P-C444 components and configuration.

7.1 Component Layout

7.1.1 Top View

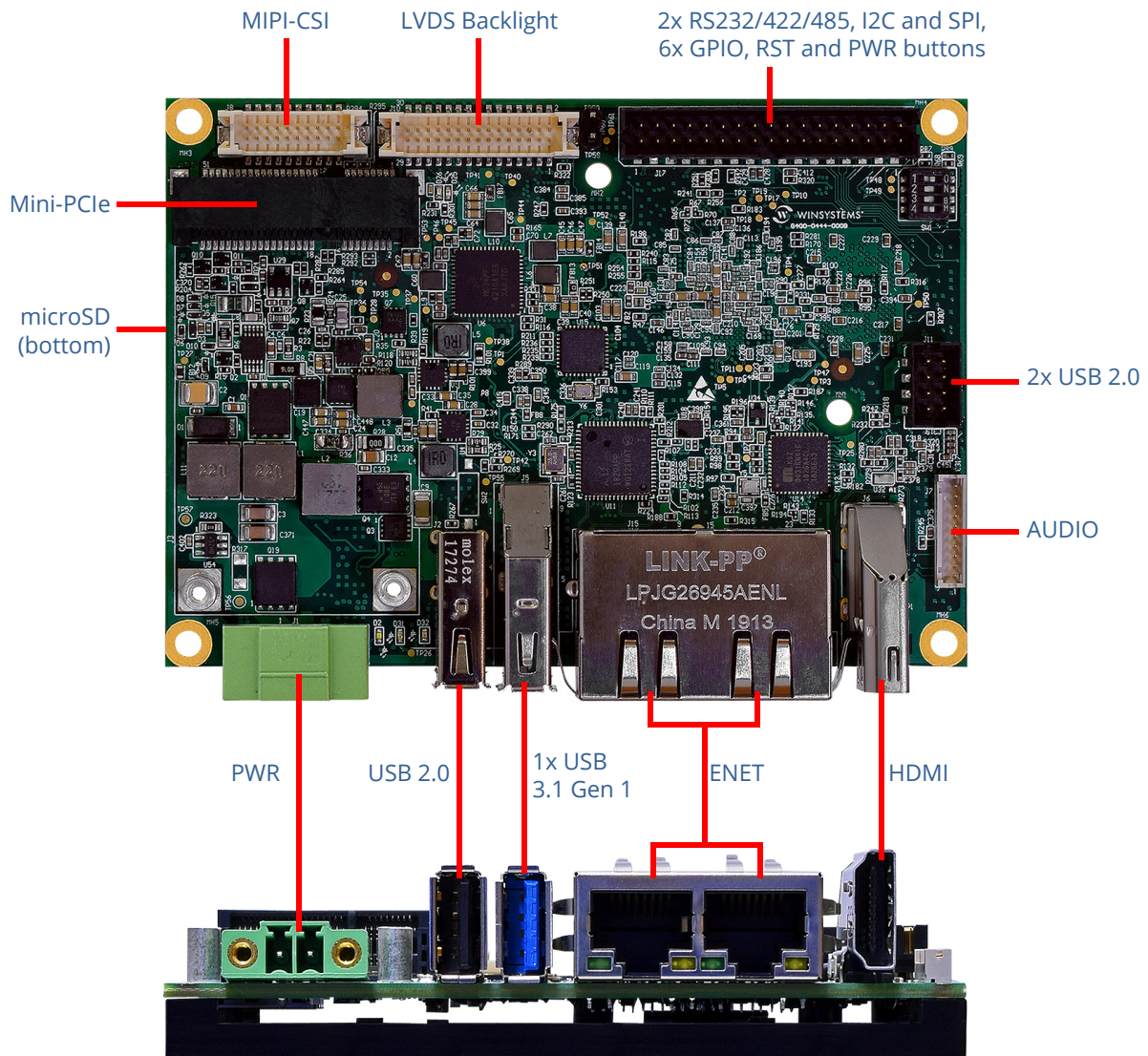

Item	Description	Reference
J12	Power Input Connector	page 12
J5	External Battery Header	page 12
J10	USB 2.0 Type A Connector	page 13
J4	Mini PCIe Connector	page 13
J13	microSD Connector	page 13
J7	USB 3.1 Gen 1 Type-A Connector	page 13
J9	HDMI	page 13
J8	HD Audio Header	page 13
J1	MIPI-CSI Header	page 14
J2	LVDS and Backlight Header	page 15
J6	USB 2.0 Header	page 16
J11	Ethernet (LAN) Dual RJ45	page 16
J3	Multi I/O (GPIO, I2C, SPI, 2x Serial, RST, and PWR Buttons)	page 17

7.2 Watchdog Timer (WDT)

7.2.1 WDT Register Usage

The watchdog timer (WDT) implemented in the ITX-P-C444 board's i.MX 8M SOC can be used to reset the system if a lock-up prevents a software task from periodically resetting the watchdog timer. The WDT is controlled through a set of standard APIs available in the provided operating systems.

7.3 Real-time Clock/Calendar

The ITX-P-C444 provides two different RTC options. Internal functionality of the i.MX 8M provides the first RTC for the system. The i.MX 8M based RTC maintains time as long as main power is connected, even when the system itself is turned off.

Additionally, an ultra-low current temperature compensated (TCXO) RTC with clock and calendar functions is provided. The RTC battery connector enables this second RTC to maintain time even when the ITX-P-C444 is disconnected from main power.

7.4 Connectors

7.4.1 J12 - Power Input Connector

Use this connection to supply power to the ITX-P-C444. This computer supports a wide range DC input power from 9 to 36 V.

Layout and Pin Reference

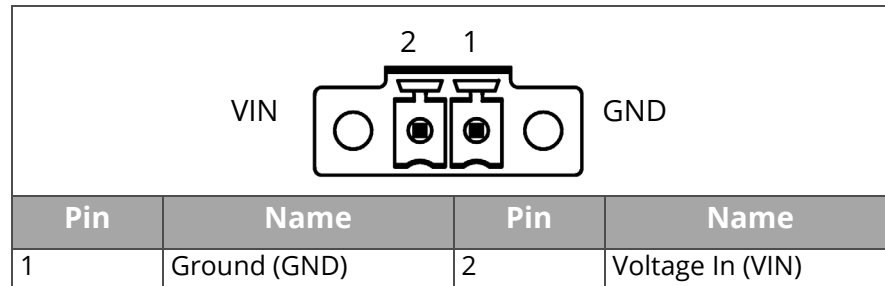

Connector

- Phoenix Contact terminal block header
Part number: 1827868

Matching Connector

- Phoenix contact terminal block plug
Part number: 1827703

7.4.2 J5 - External Battery Header

An external battery connected to the ITX-P-C444 provides standby power for the real-time clock.

Layout and Pin Reference

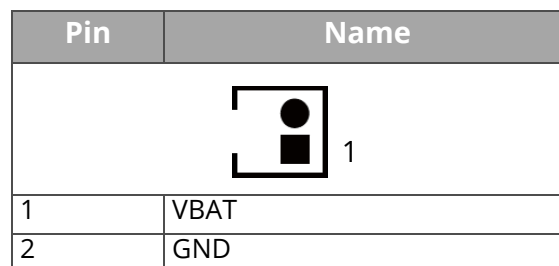

Connector

- Hirose DF13 series 1.25 mm 2-pin
Part number: DF13C-2P-1.25V (51)

Matching Connector

- Hirose DF13C 1.25 mm 2-pin
Part number: DF13C-2S-1.25C

7.4.3 J10 - USB 2.0 Type-A Connector

J2 provides one USB 2.0 Type A port. This port supplies 500 mA maximum continuous current and 480 Mbps transfer speed.

7.4.4 J4 - Mini PCIe Connector

The ITX-P-C444 Mini PCIe socket supports a variety of peripherals as available in this format. Though the sockets support other devices, they are most often used to add WiFi or 3G/LTE modem support. This Mini PCIe socket supports PCIe, and USB.

7.4.5 J13 - microSD Connector

The ITX-P-C444 provides a microSD card socket for loading operating system or for additional storage.

7.4.6 J7 - USB 3.1 Gen 1 Type-A Connector

J7 provides one USB 3.1 Gen 1 Type A port. This port supplies 1A maximum continuous current and 5 Gbps transfer speed. When using serial downloader mode, this USB port must be used. A USB 3.0 cable is not required during serial downloader mode.

7.4.7 J9 - HDMI

Standard full size HDMI 2.0a connector.

7.4.8 J8 - HD Audio Header

The HD audio header supports sample rates ranging from 44.1 to 192 kHz. The left and right front audio channels provide concurrent independent stereo sound output (multiple streaming).

Layout and Pin Reference

Pin	Name
	
1	HDA GND
2	MIC L
3	MIC R
4	HDA GND

Pin	Name
5	LINE L
6	LINE R
7	HDA GND
8	FRONT L
9	FRONT R
10	HDA GND

Connector

- Hirose DF13 series 1.25 mm 10-pin
Part number: DF13C-10P-1.25V (51)

Matching Connector

- Hirose DF13C 1.25 mm 10-pin
Part number: DF13C-10S-1.25C

7.4.9 J1 - MIPI-CSI Header

Layout and Pin Reference

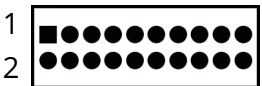
Pin			Name
			
1	DP0	2	DP1
3	DN0	4	DN1
5	GND	6	GND
7	DP2	8	DP3
9	DN2	10	DN3
11	GND	12	GND
13	CKP	14	SCL 1.8V
15	CKN	16	SDA 1.8V
17	GND	18	GND
19	VDD 3.3V	20	GPIO 3.3V

Connector

- Hirose DF13EA 1.25 mm 20-pin
Part number: DF13EA-20DP-1.25V (51)

Matching Connector

- Hirose DF13 1.25 mm 20-pin
Part number: DF13-20DS-1.25C

7.4.10 J2 - LVDS and Backlight Header

The ITX-P-C444 supports single channel LVDS flat panel displays at 24 bpp.

The LVDS output signals are odd bus, differential signals to the LVDS receiver. Each LVDS **P** output makes a differential pair with LVDS **N**.

Layout and Pin Reference

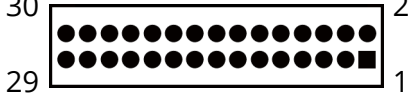
Pin	Name	Description	Pin	Name	Description
					
1	LVDSAO_P	Channel A - Positive LVDS Output	2	LVDSBO_P	Channel B - Positive LVDS Output
3	LVDSAO_N	Channel A - Negative LVDS Output	4	LVDSBO_N	Channel B - Negative LVDS Output
5	GND	Ground	6	GND	Ground
7	LVDSKO_P	Channel C - Positive LVDS Output	8	LVDSKO_N	Channel C - Negative LVDS Output
9	LVDSKO_N	Channel C - Negative LVDS Output	10	LVDSKO_P	Channel D - Positive LVDS Output
11	GND	Ground	12	GND	Ground
13	LVDSCKO_P	Positive LVDS Clock Output	14		Not Connected
15	LVDSCKO_N	Negative LVDS Clock Output	16		Not Connected
17	GND	Ground	18	GND	Ground
19	VDD_5V	+5 VDC	20	VDD_3V3	+3.3 VDC
21	VDD_5V	+5 VDC	22	VDD_3V3	+3.3 VDC
23	GND	Ground	24	GND	Ground
25	BKLT_PWM	Backlight PWM brightness control	26	BKLT_PWR	Backlight Power (+5 VDC or +12 VDC)
27	BKLT_EN	Backlight Enable	28	BKLT_PWR	Backlight Power (+5 VDC or +12 VDC)
29	SEL68	Select 8/6-bit	30	BKLT_PWR	Backlight Power (+5 VDC or +12 VDC)

Connector

- Hirose DF13 Series 1.25 mm double row 30-pin
Part number: DF13EA-30DP-1.25V(51)

Matching Connector

- Hirose DF13C 1.25 mm double row 30-pin
Part number: DF13-30DS-1.25C

7.4.11 J6 - USB 2.0 Header

J6 provides two USB 2.0 ports supplying 500 mA minimum continuous current per channel.

Layout and Pin Reference

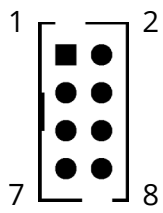
Pin	Name	Pin	Name
			
1	USB1 VCC	2	USB2 VCC
3	DATA1-	4	DATA2-
5	DATA1+	6	DATA2+
7	GND	8	GND

Connector

- Molex Milli-Grid header, shrouded with locking window
Part number: 87832-0806

Matching Connectors

- Molex Milli-Grid receptacles (with locking ramp)
Part number: 51110-0860

7.4.12 J11 - Ethernet (LAN) Dual RJ45

Two Gigabit Ethernet controllers provide standard IEEE 1588 and 802.1AS protocol timestamping. Each Ethernet interface includes 10/100/1000 Mbps multispeed, full, and half-duplex operation.

The right RJ45 port uses a RGMII PHY Ethernet controller.

The left RJ45 port uses an Intel i210 Ethernet controller.

Connector

- Gigabit dual-port RJ45 connector with integrated magnetics and LEDs

Matching Connector

- Standard Gigabit Ethernet cables with RJ45 connectors

7.4.13 J3 - Multi I/O (GPIO, I2C, SPI, 2x Serial, RST, and PWR Buttons)

The ITX-P-C444 supplies eight 5 V-tolerant GPIO lines with rising/falling edge event sense interrupt generation.

Layout and Pin Reference

Pin	Name	Pin	Name
COM Ports 1 and 2 (RS232/RS422/RS485)			
1	TX1 / TX1- / DATA1-	2	TX2 / TX2- / DATA2-
3	CTS1 / TX1+ / DATA1+	4	CTS2 / TX2+ / DATA2+
5	GND	6	GND
7	RTS1 / RX1-	8	RTS2 / RX2-
9	RX1 / RX1+	10	RX2 / RX2+
SPI			
11	SCLK OUT	12	SS OUT
13	MOSI	14	MISO
15	GND	16	GPIO INT
17	3.3 VDD	18	3.3 VDD
I2C			
19	SCL	20	GPIO INT
21	SDA	22	GND
GPIO			
23	GND	24	GPIO1
25	GPIO2	26	GPIO3
27	GPIO4	28	GPIO5
29	GPIO6	30	5 VDD
Power and Reset Buttons			
31	GND	32	Reset
33	GND	34	Power

Connector

- Molex Milli-Grid with locking windows and center polarization slot, 2.00 mm pitch, 34-pin

Part number: 878326622

Matching Connector

- Molex Milli-Grid cable to board receptacle, locking friction ramps and center polarization key, 34-pin

Part number: 875683493

7.5 Jumpers

7.5.1 SW1 - Board Configuration Jumpers

Serial downloader mode allows for the ITX-P-C444 to be programmed via USB with a new UBOOT, kernel, and/or rootfs.

Below are switch positions for different program and boot modes.

Serial Downloader Mode

- 1 = 0
- 2 = 1
- 3 = Do not care
- 4 = Do not care

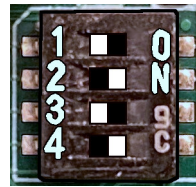

Boot from eMMC

- 1 = 1
- 2 = 0
- 3 = 0
- 4 = 1

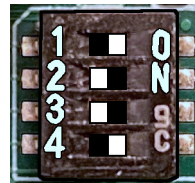

Boot from uSD

- 1 = 1
- 2 = 0
- 3 = 1
- 4 = 0

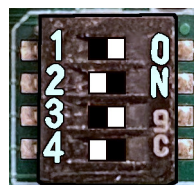

7.6 LED Indicators

LED Reference

LED	Description	Color
D1	User LED	Green
D2	Status LED	Blue
D15	Backlight indicator	White
D16	5V VDD	Yellow
D17	3.3V VDD	Red
ETH1_LED1	Activity (blinking)	Green
ETH1_LED2	Link (solid)	Yellow
ETH2_LED1	Activity (blinking)	Green
ETH2_LED2	Link (solid)	Yellow

8. UBOOT Setup

8.1 Accessing UBOOT on the ITX-P-C444

1. Using a host machine with a terminal emulator installed, plug a serial cable or serial-to-USB converter cable from the host machine to the ITX-P-C444 serial port 1.
2. Terminal serial port settings:

Baud =115,200, Data = 8 bit, Parity = none, Stop = 1 bit, Flow = none

These instructions can also be found in our BSP Documentation at <https://github.com/WinSystems/c444-manifest/wiki/BSP-Documentation>.

8.2 UBOOT, SDK, and BSP Support

WINSYSTEMS community GitHub provides online documentation regarding UBOOT, Board Support Package (BSP) documentation, and Software Development Kit (SDK) documentation.

BSP documentation includes how to build a Yocto-based Linux image with Opkg Package Manager, and update UBOOT environment variables. A kernel, and ITX-P-C444 device trees are provided as well. See <https://github.com/WinSystems/c444-manifest/wiki/BSP-Documentation>.

SDK documentation provides a bundle of tools, libraries, and drivers that are used to support development and deployment of applications on the ITX-P-C444. Yocto can build an SDK for the target platform, allowing

developers to build and deploy applications, UBOOT, and the kernel remotely. See <https://github.com/WinSystems/c444-manifest/wiki/SDK-Documentation>.

9. Accessories and Cables

WINSYSTEMS cables and batteries simplify connection to the ITX-P-C444. The following table lists available items.

Go to www.winsystems.com for more information on WINSYSTEMS cables and batteries.

Item	Part Number	Connection	Description
Cable	CBL-LVDSB-021-20	J2 - LVDS data and backlight header on page 15	Hirose DF13C 1.25 mm double row 30-pin
Cable	CBL-AUDIO-001-20A	J8 - HD audio header on page 13	Hirose DF13C 1.25 mm 10-pin
Cable	CBL-USB2-006-12A	J6 - USB 2.0 port 2x header on page 16	Molex Milli-Grid receptacles
Cable	CBL-MULTI-IO-12A	J3 - Multi I/O (GPIO, I2C, SPI, 2x Serial, RST, and PWR buttons) on page 17	Molex Milli-Grid, 2.00mm pitch, 34-pin
Battery	BAT-LPC-BR2330	J5 - External battery header on page 12	Hirose DF13C 1.25 mm 2-pin

10. Software Drivers

Go to www.winsystems.com for information on available software drivers.

Appendix A. Best Practices

The following paragraphs outline the best practices for operating the ITX-P-C444 in a safe, effective manner, that does not damage the board. Read this section carefully.

Power Supply



Avoid electrostatic discharge (ESD)

Only handle the circuit board and other bare electronics when electrostatic discharge (ESD) protection is in place. Having a wrist strap and a fully grounded workstation is the minimum ESD protection required before the ESD seal on the product bag is broken.

Power Supply Budget

Evaluate your power supply budget. It is usually good practice to budget twice the typical power requirement for all of your devices.

Zero-load Power Supply

Use a zero-load power supply whenever possible. A zero-load power supply does not require a minimum power load to regulate. If a zero-load power supply is not appropriate for your application, then verify that the single board computer's typical load is not lower than the power supply's minimum load. If the single board computer does not draw enough power to meet the power supply's minimum load, then the power supply does not regulate properly and can cause damage to the ITX-P-C444.



Use proper power connections (voltage)

When verifying the voltage, measure it at the power connector on the ITX-P-C444. Measuring it at the power supply does not account for voltage drop through the wire and connectors.

The ITX-P-C444 requires 9V to 36V to operate. Verify the power connections. Incorrect voltages can cause catastrophic damage.

The ITX-P-C444 has a single power connector at J1. A single 9V-36V DC input and ground is required to power the board.

Power Harness

Minimize the length of the power harness. This reduces the amount of voltage drop between the power supply and the ITX-P-C444.

Gauge Wire

Use the largest gauge wire that you can. Most connector manufacturers have a maximum gauge wire they recommend for their pins.

Contact Points

WINSYSTEMS boards mostly use connectors with gold finish contacts. Gold finish contacts are used exclusively on high-speed connections. Power and lower speed peripheral connectors may use a tin finish as an alternative contact surface. It is critical that the contact material in the mating connectors is matched properly (gold to gold and tin to tin). Contact areas made with dissimilar metals can cause oxidation/corrosion, resulting in unreliable connections.

Pin Contacts

Often the pin contacts used in cabling are not given enough attention. The ideal choice for a pin contact would include a design similar to Molex or Trifurcon designs, which provide three distinct points to maximize the contact area and improve connection integrity in high shock and vibration applications.

Power Down

Make sure that power has been removed from the system before making or breaking any connections.



Power supply OFF—Always turn off the power supply before connecting to the I/O Module. Do not hot-plug the ITX-P-C444 on a host platform that is already powered.

I/O connections OFF—Turn off all I/O connections before connecting them to the embedded computer modules or any I/O cards. Connecting hot signals can cause damage whether the embedded system is powered or not.

Mounting and Protecting the I/O Module

Placing the ITX-P-C444 on mounting standoffs—Be careful when placing the ITX-P-C444 on the mounting standoffs. Sliding the board around until the standoffs are visible from the top can cause component damage on the bottom of the board.

Do not bend or flex the ITX-P-C444—Bending or flexing can cause irreparable damage. Embedded computer modules are especially sensitive to flexing or bending around ball grid array (BGA) devices. BGA devices are extremely rigid by design, and flexing or bending the

embedded computer module can cause the BGA to tear away from the printed circuit board.

Mounting holes—The mounting holes are plated on the top, bottom, and through the barrel of the hole. Traces are often routed in the inner layers right below, above, or around the mounting holes.

- Never use a drill or any other tool in an attempt to make the holes larger.
- Never use screws with oversized heads. The head could come in contact with nearby components causing a short or physical damage.
- Never use self-tapping screws; they compromise the walls of the mounting hole.
- Never use oversized screws that cut into the walls of the mounting holes.
- Always use all of the mounting holes. By using all of the mounting holes, you provide the support the embedded computer module needs to prevent bending or flexing.

Plug or unplug connectors only on fully mounted boards—Never plug or unplug connectors on a board that is not fully mounted. Many of the connectors fit rather tightly and the force needed to plug or unplug them could cause the embedded computer module to be flexed.

Avoid cutting the ITX-P-C444—Never use star washers or any fastening hardware that cut into the ITX-P-C444.

Avoid over-tightening of mounting hardware—Causing the area around the mounting holes to compress could damage interlayer traces around the mounting holes.

Use appropriate tools—Always use tools that are appropriate for working with small hardware. Large tools can damage components around the mounting holes.

Avoid conductive surfaces—Never allow the embedded computer module to be placed on a conductive surface. Many embedded systems use a battery to back up the clock-calendar and CMOS memory. A conductive surface such as a metal bench can short the battery causing premature failure.

Conformal Coating

Applying conformal coating to a WINSYSTEMS product does not in itself void the product warranty, if it is properly removed prior to return. Coating can change thermal characteristics and impedes our ability to test, diagnose, and repair products. Any coated product sent to WINSYSTEMS for repair will be returned at customer expense and no service will be performed.

Operations/Product Manuals

Every single board computer has an Operations manual or Product manual.

Periodic updates—Operations/product manuals are updated often. Periodically check the WINSYSTEMS website (<http://www.winsystems.com>) for revisions.

Check pinouts—Always check the pinout and connector locations in the manual before plugging in a cable. Many I/O modules have identical headers for different functions and plugging a cable into the wrong header can have disastrous results.

Contact an applications engineer—If a diagram or chart in a manual does not seem to match your board, or if you have additional questions, contact a WINSYSTEMS applications engineer at +1-817-274-7553.

Appendix B. Mechanical Drawings

ITX-P-C444 Mechanical Drawings

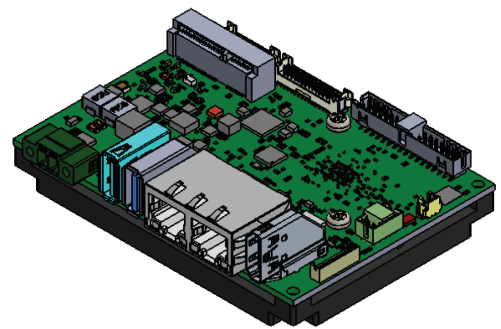
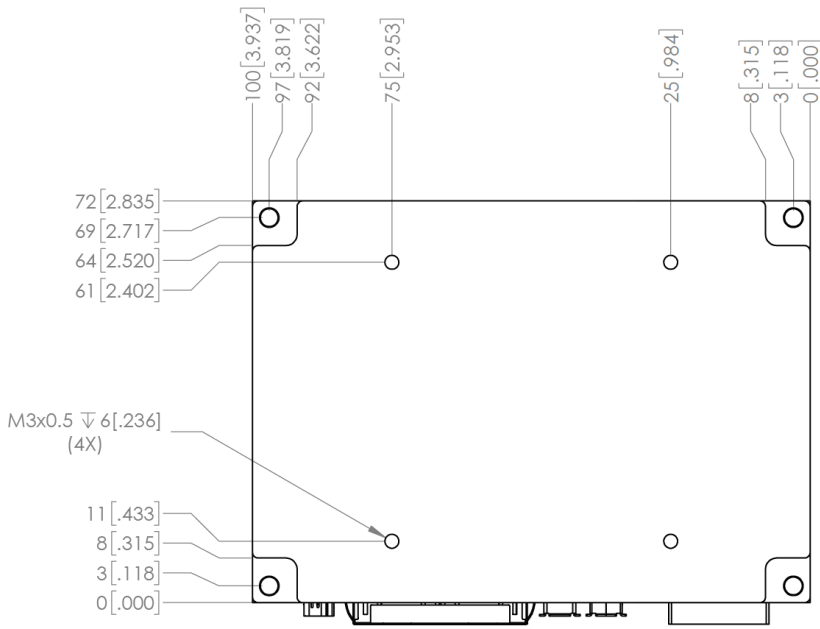
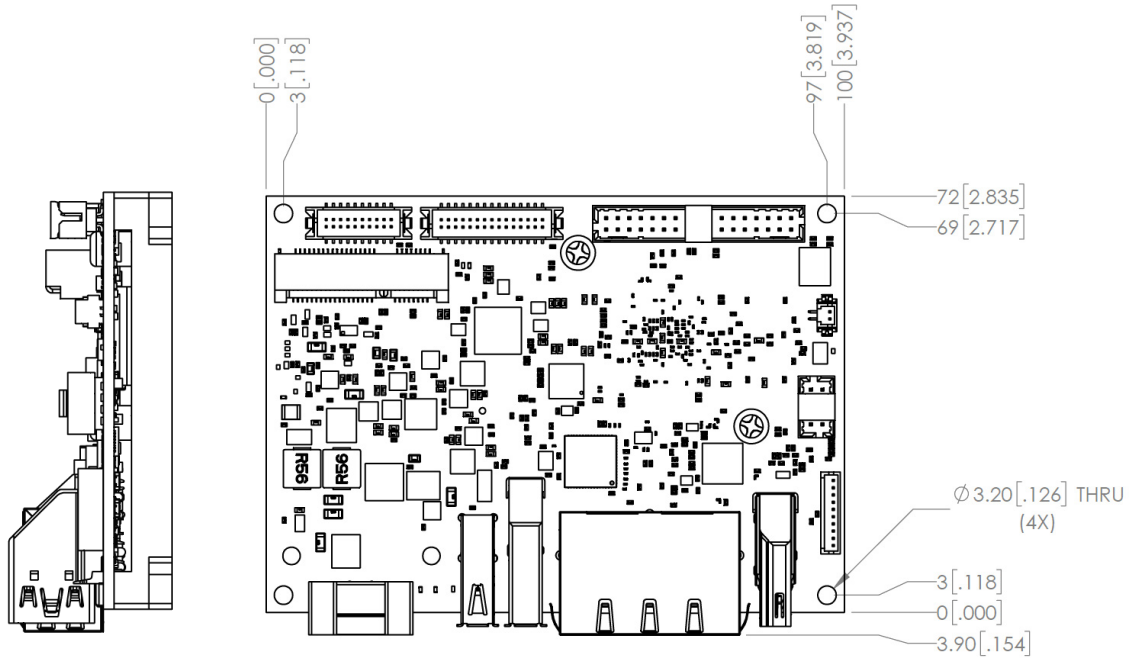

Appendix C. Warranty Information

WINSYSTEMS warrants that for a period of two (2) years from the date of shipment, any Products and Software purchased or licensed hereunder which have been developed or manufactured by WINSYSTEMS shall be free of any defects and shall perform substantially in accordance with WINSYSTEMS' specifications therefor. With respect to any Products or Software purchased or licensed hereunder which have been developed or manufactured by others, WINSYSTEMS shall transfer and assign to Customer any warranty of such manufacturer or developer held by WINSYSTEMS, provided that the warranty, if any, may be assigned. The sole obligation of WINSYSTEMS for any breach of warranty contained herein shall be, at its option, either (i) to repair or replace at its expense any materially defective Products or Software, or (ii) to take back such Products and Software and refund the Customer the purchase price and any license fees paid for the same. Customer shall pay all freight, duty, broker's fees, insurance, charges and other fees and charges for the return of any Products or Software to WINSYSTEMS under this warranty. WINSYSTEMS shall pay freight and insurance charges for any repaired or replaced Products or Software thereafter delivered to Customer within the United States. All fees and costs for shipment outside of the United States shall be paid by Customer. The foregoing warranty shall not apply to any Products or Software which have been subject to abuse, misuse, vandalism, accident, alteration, neglect, unauthorized repair or improper installation.

THERE ARE NO WARRANTIES BY WINSYSTEMS EXCEPT AS STATED HEREIN. THERE ARE NO OTHER WARRANTIES EXPRESS OR IMPLIED INCLUDING, BUT NOT LIMITED TO, THE IMPLIED WARRANTIES OF MERCHANTABILITY AND FITNESS FOR A PARTICULAR PURPOSE. IN NO EVENT SHALL WINSYSTEMS BE LIABLE FOR CONSEQUENTIAL, INCIDENTAL OR SPECIAL DAMAGES FOR LOSS OF DATA, PROFITS OR GOODWILL. WINSYSTEMS' MAXIMUM LIABILITY FOR ANY BREACH OF THIS AGREEMENT OR OTHER CLAIM RELATED TO ANY PRODUCTS, SOFTWARE, OR THE SUBJECT MATTER HEREOF, SHALL NOT EXCEED THE PURCHASE PRICE OR LICENSE FEE PAID BY CUSTOMER TO WINSYSTEMS FOR THE PRODUCTS OR SOFTWARE OR PORTION THEREOF TO WHICH SUCH BREACH OR CLAIM PERTAINS.

Title to the Products shall remain vested in WINSYSTEMS until complete payment is made by Customer. Title to any Software shall remain vested in WINSYSTEMS, or WINSYSTEMS' licensor from whom WINSYSTEMS has obtained marketing rights, both before, during and after the term of the License. Nonpayment when due of the purchase price for any Products or the License fees for any Software, or, if applicable, taxes and/or the cost of any freight and insurance for any Products and/or Software, shall entitle WINSYSTEMS to take possession of the Products and/or Software without notice to Customer or prejudice to WINSYSTEMS' rights under contract or any other legal remedy.

Until title to the Products pass in accordance with the provision set out above, except with the prior written approval of WINSYSTEMS, no Products shall be modified, altered, moved or in any way assigned, sublet, mortgaged or charged nor may Customer part with possession of all or part of the same.

There are no understandings, agreements or representations, express or implied, other than those set forth herein. This Order embodies the entire agreement between the parties and may be waived, amended or supplemented only by a written instrument executed jointly by WINSYSTEMS and Customer as evidenced only by the signature of duly authorized officers of each party. The foregoing terms and conditions of any order which may be issued by Customer for the purchase of Products or licensing of Software hereunder.

In the event this Order is placed in the hands of an attorney or collection agency by WINSYSTEMS to collect any sums due hereunder to WINSYSTEMS, Customer shall pay all reasonable attorney's fees, expenses, collection and court costs incurred by WINSYSTEMS.

THIS AGREEMENT SHALL BE GOVERNED AND CONSTRUED UNDER THE TEXAS UNIFORM COMMERCIAL CODE AND THE APPLICABLE LAWS OF THE STATE OF TEXAS. THE PARTIES ACKNOWLEDGE THAT ANY ACTION BROUGHT HEREUNDER SHALL ONLY BE BROUGHT IN A COURT OF COMPETENT JURISDICTION IN TARRANT COUNTY, TEXAS.

Warranty Service

1. To obtain service under this warranty, obtain a return authorization number. In the United States, contact the WINSYSTEMS Service Center for a return authorization number. Outside the United States, contact your local sales agent for a return authorization number.
2. You must send the product postage prepaid and insured. You must enclose the products in an anti-static bag to protect from damage by static electricity. WINSYSTEMS is not responsible for damage to the product due to static electricity.